

Cambridge Technicals

Engineering

Unit 4: Principles of electrical and electronic engineering

Level 3 Cambridge Technical Certificate/Diploma in Engineering
05822 - 05825

Mark Scheme for June 2016

OCR (Oxford Cambridge and RSA) is a leading UK awarding body, providing a wide range of qualifications to meet the needs of candidates of all ages and abilities. OCR qualifications include AS/A Levels, Diplomas, GCSEs, Cambridge Nationals, Cambridge Technicals, Functional Skills, Key Skills, Entry Level qualifications, NVQs and vocational qualifications in areas such as IT, business, languages, teaching/training, administration and secretarial skills.

It is also responsible for developing new specifications to meet national requirements and the needs of students and teachers. OCR is a not-for-profit organisation; any surplus made is invested back into the establishment to help towards the development of qualifications and support, which keep pace with the changing needs of today's society.

This mark scheme is published as an aid to teachers and students, to indicate the requirements of the examination. It shows the basis on which marks were awarded by examiners. It does not indicate the details of the discussions which took place at an examiners' meeting before marking commenced.

All examiners are instructed that alternative correct answers and unexpected approaches in candidates' scripts must be given marks that fairly reflect the relevant knowledge and skills demonstrated.

Mark schemes should be read in conjunction with the published question papers and the report on the examination.

OCR will not enter into any discussion or correspondence in connection with this mark scheme.

© OCR 2016

1. Annotations

Annotation	Meaning
tick	Correct response
cross	Incorrect response
Omission mark (carat)	Incomplete response
ECF	Error carried forward
BOD	Benefit of doubt
NBOD	No benefit of doubt

2. Subject-specific marking instructions

In all numerical calculation questions a correct response will gain all marks unless specified otherwise.

Question			Answer	Marks	Guidance
1	(a)	(i)	$W = Pt = 300 \times 5$ $= 1500 \text{ (Wh)} / 1.5 \text{ (kWh)}$ OR $300 \times (5 \times 3600) = 5\,400\,000 \text{ (J)}$	1 1	(Applying knowledge from Unit 2 LO3)
		(ii)	$I = P/V \quad I = 300/240$ $I = 1.25 \text{ (A)}$	1 1	(Applying knowledge from Unit 2 LO3)
	(b)	(i)	$V = IR \quad = 6 \times 2$ $= 12 \text{ (V)}$	1 1	(Applying knowledge from Unit 2 LO3)
		(ii)	$= I_1 + I_2 + I_3$ (Kirchoff's current law) / $I_3 = V/R = 24/16 = 1.5 \text{ (A)}$ $I = 1 + 2 + 1.5$ $I = 4.5 \underline{\text{A}}$ OR alternative answer: $I_{\text{total}} = \frac{24}{R_{\text{total}}}$ (1 mark allow ecf for R_{total}) $R_{\text{t}} = \left(\frac{1}{24} + \frac{1}{6 + \frac{12}{2}} + \frac{1}{16} \right)^{-1}$ (1 mark) $= 5.33 \text{ (}\Omega\text{)}$ (1 mark) $I_{\text{total}} = 4.5 \underline{\text{A}}$ (1 mark with the correct unit)	1 1 1 1	(Applying knowledge from Unit 2 LO3) Award one mark for correct numerical result with the unit.

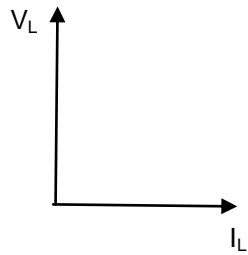

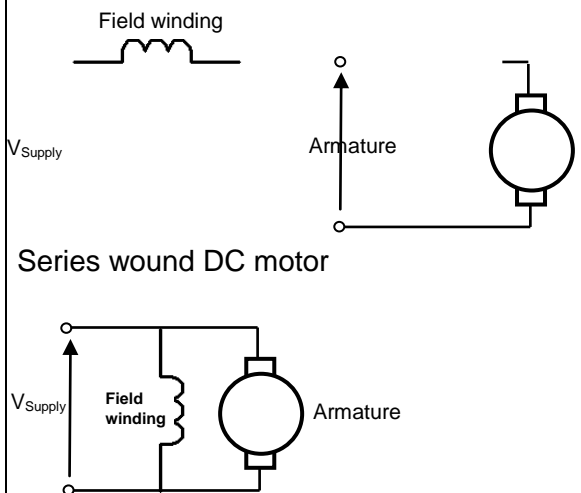

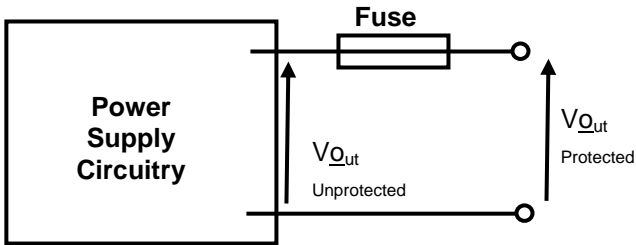

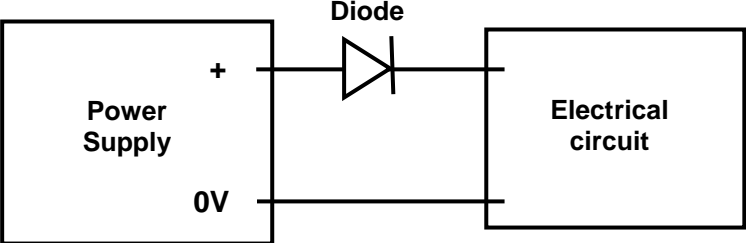
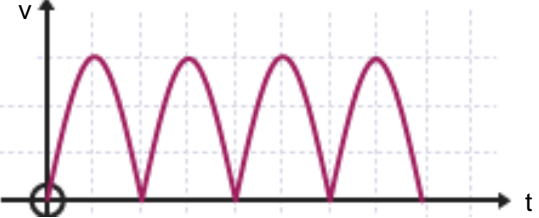
Question		Answer	Marks	Guidance
2	(a)		1 1	Award one mark for presenting a phasor diagram with V_L and I_L 90° out of phase. Award one mark for I_L lagging V_L .
	(b)	$X_C = \frac{1}{2 \times \pi \times 60 \times 22 \mu}$ $X_C = 120.6 \text{ } (\Omega)$ $Z = \sqrt{50^2 + 120.6^2}$ $Z = 130.6 \text{ } (\Omega)$	1 1 1 1	$X_C = \frac{1}{2\pi f c}$ $Z = \sqrt{R^2 + X_c^2}$ <p>Allow use of $X_c = \frac{1}{2} \pi f C$ <u>this series only</u> (as quoted in April 2016 version of formula booklet):</p> $X_c = \frac{1}{2} \pi 60 \times 22 \mu \text{ (1mark)}$ $X_c = 2.073 \times 10^{-3} \text{ } (\Omega) \text{ (1 mark)}$ $= \sqrt{50^2 + (2.073 \times 10^{-3})^2} \text{ (1 mark)}$ $= 50 \text{ } (\Omega) \text{ (1 mark)}$

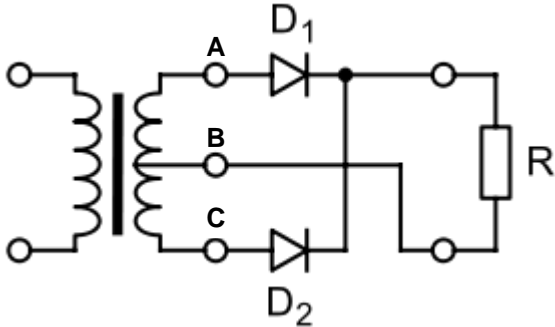
Question	Answer	Marks	Guidance
(c)	$X_L = 2 \times \pi \times 50 \times 0.2 = 62.8(\Omega)$ $Z = \sqrt{50^2 + 62.8^2} = 80.3(\Omega)$ $\text{Cos } \phi = 50/80.3$ $\text{Phase angle } (\phi) = 51.5^\circ$	<p>1</p> <p>1</p> <p>1</p> <p>1</p>	$Z = \sqrt{R^2 + X_L^2} \quad X_L = 2\pi fL$ <p>Cos $\phi = R/Z$ Award one mark for correct numerical result with the correct unit.</p>
3 (a)	Converts/transfers mechanical/kinetic energy to electrical energy	1	
(b)	 <p>Series wound DC motor</p> <p>Shunt wound DC motor</p> <p>Series wound – field winding connected in series with the armature. Shunt wound – field winding connected in parallel with the armature.</p>	<p>1</p> <p>1</p> <p>2</p>	<p>Award one mark for diagram showing armature and field winding in series. Note: Armature resistance can also be included. Circuit symbols are not required.</p> <p>Award one mark for diagram showing armature and field winding in parallel Note: Armature resistance can also be included. Circuit symbols are not required.</p> <p>Award up to two marks for a written explanation which clarifies understanding; this can be included as annotation on the diagram(s).</p>

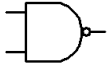
Question		Answer	Marks	Guidance
	(c) (i)	$I_f = V_f / R_f = 240 / 100$ $= 2.4 \text{ (A)}$	1 1	(Applying knowledge from Unit 2 LO3)
	(ii)	$I_a = I_L - I_f = 30 - 2.4$ $I_a = 27.6 \text{ (A)}$ $E = V - I_a R_a = 240 - (27.6 \times 0.4)$ $E = 229 \text{ V}$	1 1 1 1	(Applying knowledge from Unit 2 LO3) Award one mark for the correct numerical result with the unit.
4	(a) (i)	 <p>Explanation any one from e.g.:</p> <ul style="list-style-type: none"> • Fuse will protect against too much current being drawn from the power supply. • Fuse will protect against the power supply overheating. • The fuse is a piece of wire which melts when the current flowing through it exceeds its stated current. • If the fuse blows there is an open circuit and no current flows. 	1 1	Award 1 mark for a suitable diagram, with/without power supply which clearly shows the fuse protecting a component/circuit. Award 1 mark for a valid explanation.

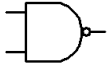
Question			Answer	Marks	Guidance
4	(a)	(ii)	 <p>Explanation any one from e.g.:</p> <ul style="list-style-type: none"> • No current will flow into the electronic circuit if power supply polarity is reversed. • Current will only flow through the diode and into the electronic circuit when the diode is forward biased. 	1 1	Award 1 mark for a suitable diagram, with/without power supply which clearly shows the diode protecting a component/circuit, the diode must be the correct way around. Award 1 mark for a valid explanation
	(b)			1 1	Axis correctly drawn and labelled Full wave rectified voltage signal correctly drawn

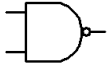
Question	Answer	Marks	Guidance
(c)	 <p>Explanation e.g.:</p> <ul style="list-style-type: none"> • When the anode of D1 (A) is sufficiently more positive (0.6V) than the centre tap of the transformer (B) a current flows through the load resistor R. • When the anode of D2 (C) is sufficiently more positive (0.6V) than the centre tap of the transformer (B) a current flows through the load resistor R. • The current flowing through the load is the same direction for both half cycles. 	<p>1</p> <p>1</p> <p>2</p>	<p>1 mark for correct drawing of a centre tapped transformer and load resistor R/ V_{out}.</p> <p>Award 1 mark for correct diode arrangement.</p> <p>Award a maximum of 2 marks to for the written explanation.</p>
5 (a)	<p>Analogue signal varies continuously with time. Digital signal is either on or off/1 or 0/high or low.</p>	<p>1</p> <p>1</p>	<p>Accept any of the options given to explain the digital signal</p>
(b) (i)	<p>Non-inverting amplifier Any two from:</p> <ul style="list-style-type: none"> • Voltage gain (amount of amplification) determined by the ratio of the 2 (feedback) resistors. • Resistors provide negative feedback. • Feedback reduces the high gain of the operational amplifier. 	<p>1</p> <p>2</p>	<p>Award 1 mark for the name Award a maximum of 2 marks for the explanation</p>

Question	Answer	Marks	Guidance																																																						
(ii)	$\text{Voltage Gain} = 1 + \frac{R2}{R1}$ $\text{Voltage Gain} = 1 + \frac{100K\Omega}{10K\Omega} = 11$ $\text{Voltage Gain} = \frac{V_{out}}{V_{in}}$ $V_{out} = \text{Voltage Gain} \times V_{in} = 11 \times 0.2 = 2.2V$	<p>1</p> <p>1</p> <p>1</p>	<p>Formula provided</p> <p>Award one mark for correct numerical result (ignore unit)</p> <p>Award one mark for recalling formula</p> <p>Award one mark for correct numerical result with unit.</p>																																																						
6 (a)	<table border="1" data-bbox="353 751 963 991"> <thead> <tr> <th>Component Name</th> <th>Circuit Symbol</th> </tr> </thead> <tbody> <tr> <td>NAND</td> <td></td> </tr> <tr> <td>XOR</td> <td></td> </tr> </tbody> </table>	Component Name	Circuit Symbol	NAND		XOR		<p>1</p> <p>1</p>	<p>Award 1 mark for correct symbol.</p> <p>Award 1 mark for correct symbol.</p>																																																
Component Name	Circuit Symbol																																																								
NAND																																																									
XOR																																																									
(b)	<table border="1" data-bbox="499 1058 808 1377"> <thead> <tr> <th>A</th> <th>B</th> <th>C</th> <th>D</th> <th>E</th> <th>Q</th> </tr> </thead> <tbody> <tr><td>0</td><td>0</td><td>0</td><td>0</td><td>1</td><td>1</td></tr> <tr><td>0</td><td>0</td><td>1</td><td>0</td><td>0</td><td>0</td></tr> <tr><td>0</td><td>1</td><td>0</td><td>0</td><td>1</td><td>1</td></tr> <tr><td>0</td><td>1</td><td>1</td><td>0</td><td>0</td><td>0</td></tr> <tr><td>1</td><td>0</td><td>0</td><td>0</td><td>1</td><td>1</td></tr> <tr><td>1</td><td>0</td><td>1</td><td>0</td><td>0</td><td>0</td></tr> <tr><td>1</td><td>1</td><td>0</td><td>1</td><td>1</td><td>1</td></tr> <tr><td>1</td><td>1</td><td>1</td><td>1</td><td>0</td><td>1</td></tr> </tbody> </table>	A	B	C	D	E	Q	0	0	0	0	1	1	0	0	1	0	0	0	0	1	0	0	1	1	0	1	1	0	0	0	1	0	0	0	1	1	1	0	1	0	0	0	1	1	0	1	1	1	1	1	1	1	0	1	<p>4</p>	<p>Two correct complete rows equals one mark Four correct complete rows equals two marks Six correct complete rows equals three marks Eight correct complete rows equals four marks Do not reward repeats</p>
A	B	C	D	E	Q																																																				
0	0	0	0	1	1																																																				
0	0	1	0	0	0																																																				
0	1	0	0	1	1																																																				
0	1	1	0	0	0																																																				
1	0	0	0	1	1																																																				
1	0	1	0	0	0																																																				
1	1	0	1	1	1																																																				
1	1	1	1	0	1																																																				

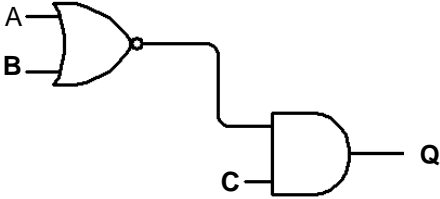
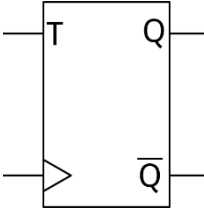
Question	Answer	Marks	Guidance
(c)		<p>1</p> <p>1</p>	<p>Award 1 mark for identifying NOR gate with correct inputs.</p> <p>Award 1 mark for identifying AND gate with correct inputs.</p> <p>Accept any alternative combination that yields the same Boolean expression</p>
(d)	 <p>Logic 1 on T input – Output toggles when clock signal applied. Logic 0 on T input – No change to output when clock applied.</p>	<p>1</p> <p>1</p>	<p>Award 1 mark for correct symbol.</p> <p>Accept CK for clock input</p> <p>A truth table is also acceptable here.</p>

OCR (Oxford Cambridge and RSA Examinations)
1 Hills Road
Cambridge
CB1 2EU

OCR Customer Contact Centre

Education and Learning

Telephone: 01223 553998

Facsimile: 01223 552627

Email: general.qualifications@ocr.org.uk

www.ocr.org.uk

For staff training purposes and as part of our quality assurance programme your call may be recorded or monitored

Oxford Cambridge and RSA Examinations
is a Company Limited by Guarantee
Registered in England
Registered Office; 1 Hills Road, Cambridge, CB1 2EU
Registered Company Number: 3484466
OCR is an exempt Charity

OCR (Oxford Cambridge and RSA Examinations)
Head office
Telephone: 01223 552552
Facsimile: 01223 552553

© OCR 2016

