

Mathematics (MEI)

Advanced GCE A2 7895-8

Advanced Subsidiary GCE AS 3895-8

Mark Schemes for the Units

January 2010

3895-8/7895-8/MS/10J

OCR (Oxford Cambridge and RSA) is a leading UK awarding body, providing a wide range of qualifications to meet the needs of pupils of all ages and abilities. OCR qualifications include AS/A Levels, Diplomas, GCSEs, OCR Nationals, Functional Skills, Key Skills, Entry Level qualifications, NVQs and vocational qualifications in areas such as IT, business, languages, teaching/training, administration and secretarial skills.

It is also responsible for developing new specifications to meet national requirements and the needs of students and teachers. OCR is a not-for-profit organisation; any surplus made is invested back into the establishment to help towards the development of qualifications and support which keep pace with the changing needs of today's society.

This mark scheme is published as an aid to teachers and students, to indicate the requirements of the examination. It shows the basis on which marks were awarded by Examiners. It does not indicate the details of the discussions which took place at an Examiners' meeting before marking commenced.

All Examiners are instructed that alternative correct answers and unexpected approaches in candidates' scripts must be given marks that fairly reflect the relevant knowledge and skills demonstrated.

Mark schemes should be read in conjunction with the published question papers and the Report on the Examination.

OCR will not enter into any discussion or correspondence in connection with this mark scheme.

© OCR 2010

Any enquiries about publications should be addressed to:

OCR Publications
PO Box 5050
Annesley
NOTTINGHAM
NG15 0DL

Telephone: 0870 770 6622
Facsimile: 01223 552610
E-mail: publications@ocr.org.uk

CONTENTS

Advanced GCE Further Mathematics (MEI) (7896)
Advanced GCE Further Mathematics (Additional) (MEI) (7897)
Advanced GCE Mathematics (MEI) (7895)
Advanced GCE Pure Mathematics (MEI) (7898)

Advanced Subsidiary GCE Further Mathematics (MEI) (3896)
Advanced Subsidiary GCE Further Mathematics (Additional) (MEI) (3897)
Advanced Subsidiary GCE Mathematics (MEI) (3895)
Advanced Subsidiary GCE Pure Mathematics (MEI) (3898)

MARK SCHEMES FOR THE UNITS

| Unit/Content | Page |
|--|-------------|
| 4751 (C1) Introduction to Advanced Mathematics | 1 |
| 4752 (C2) Concepts for Advanced Mathematics | 7 |
| 4753 (C3) Methods for Advanced Mathematics | 10 |
| 4754 (C4) Applications of Advanced Mathematics | 14 |
| 4755 (FP1) Further Concepts for Advanced Mathematics | 19 |
| 4756 (FP2) Further Methods for Advanced Mathematics | 24 |
| 4758 Differential Equations | 29 |
| 4761 Mechanics 1 | 33 |
| 4762 Mechanics 2 | 38 |
| 4763 Mechanics 3 | 42 |
| 4766 Statistics 1 | 46 |
| 4767 Statistics 2 | 50 |
| 4768 Statistics 3 | 54 |
| 4771 Decision Mathematics 1 | 59 |
| 4776 Numerical Methods | 64 |
| Grade Thresholds | 67 |

4751 (C1) Introduction to Advanced Mathematics

| | | | |
|--------|--|------------------------|---|
| 1 | $[a =]2c^2 - b$ www o.e. | 3 | M1 for each of 3 complete correct steps, ft from previous error if equivalent difficulty |
| 2 | $5x - 3 < 2x + 10$ $3x < 13$ $x < \frac{13}{3}$ o.e. | M1 M1 M1 | condone '=' used for first two Ms M0 for just $5x - 3 < 2(x + 5)$ or $-13 < -3x$ or ft or ft; isw further simplification of $13/3$; M0 for just $x < 4.3$ |
| 3 (i) | (4, 0) | 1 | allow $y = 0, x = 4$ bod B1 for $x = 4$ but do not isw: 0 for (0, 4) seen 0 for (4, 0) and (0, 10) both given (choice) unless (4, 0) clearly identified as the x -axis intercept |
| 3 (ii) | $5x + 2(5 - x) = 20$ o.e. (10/3, 5/3) www isw | M1 A2 | for subst or for multn to make coeffs same and appropriate addn/subtn; condone one error or A1 for $x = 10/3$ and A1 for $y = 5/3$ o.e. isw; condone 3.33 or better and 1.67 or better A1 for (3.3, 1.7) |
| 4 (i) | translation by $\begin{pmatrix} -4 \\ 0 \end{pmatrix}$ or 4 [units] to left | B1 B1 | 0 for shift/move or 4 units in negative x direction o.e. |
| 4 (ii) | sketch of parabola right way up and with minimum on negative y -axis min at (0, -4) and graph through -2 and 2 on x -axis | B1 B1 | mark intent for both marks must be labelled or shown nearby |
| 5 (i) | $\frac{1}{12}$ or $\pm \frac{1}{12}$ | 2 | M1 for $\frac{1}{144^{\frac{1}{2}}}$ o.e. or for $\sqrt{144} = 12$ soi |
| 5 (ii) | denominator = 18 numerator = $5 - \sqrt{7} + 4(5 + \sqrt{7})$ = $25 + 3\sqrt{7}$ as final answer | B1 M1 A1 | B0 if 36 after addition for M1, allow in separate fractions allow B3 for $\frac{25 + 3\sqrt{7}}{18}$ as final answer www |

| | | | |
|--------|--|--|--|
| 6 (i) | <p>cubic correct way up and with two turning pts</p> <p>touching x-axis at -1, and through it at 2.5 and no other intersections</p> <p>y- axis intersection at -5</p> | <p>B1</p> <p>B1</p> <p>B1</p> | <p>intns must be shown labelled or worked out nearby</p> |
| 6 (ii) | $2x^3 - x^2 - 8x - 5$ | <p>2</p> | <p>B1 for 3 terms correct or M1 for correct expansion of product of two of the given factors</p> |
| 7 | <p>attempt at $f(-3)$ $-27 + 18 - 15 + k = 6$</p> <p>$k = 30$</p> | <p>M1</p> <p>A1</p> <p>A1</p> | <p>or M1 for long division by $(x + 3)$ as far as obtaining $x^2 - x$ and A1 for obtaining remainder as $k - 24$ (but see below)</p> <p>equating coefficients method: M2 for $(x + 3)(x^2 - x + 8) [+6]$ o.e. (from inspection or division) eg M2 for obtaining $x^2 - x + 8$ as quotient in division</p> |
| 8 | $x^3 + 15x + \frac{75}{x} + \frac{125}{x^3}$ www isw or $x^3 + 15x + 75x^{-1} + 125x^{-3}$ www isw | <p>4</p> | <p>B1 for both of x^3 and $\frac{125}{x^3}$ or $125x^{-3}$ isw</p> <p>and</p> <p>M1 for 1 3 3 1 soi; A1 for each of $15x$ and $\frac{75}{x}$ or $75x^{-1}$ isw</p> <p>or</p> <p>SC2 for completely correct unsimplified answer</p> |

| | | | |
|---|--|--|--|
| <p>9</p> <p>$x^2 - 5x + 7 = 3x - 10$</p> <p>$x^2 - 8x + 17 [= 0]$ o.e or $y^2 - 4y + 13 [= 0]$ o.e</p> <p>use of $b^2 - 4ac$ with numbers subst (condone one error in substitution) (may be in quadratic formula)</p> <p>$b^2 - 4ac = 64 - 68$ or -4 cao [or $16 - 52$ or -36 if y used]</p> <p>[< 0] so no [real] roots [so line and curve do not intersect]</p> | | <p>M1</p> <p>M1</p> <p>M1</p> <p>A1</p> <p>A1</p> | <p>or attempt to subst $(y + 10)/3$ for x</p> <p>condone one error; allow M1 for $x^2 - 8x = -17$ [oe for y] only if they go on to completing square method</p> <p>or $(x - 4)^2 = 16 - 17$ or $(x - 4)^2 + 1 = 0$ (condone one error)</p> <p>or $(x - 4)^2 = -1$ or $x = 4 \pm \sqrt{-1}$ [or $(y - 2)^2 = -9$ or $y = 2 \pm \sqrt{-9}$]</p> <p>or conclusion from comp. square; needs to be explicit correct conclusion and correct ft; allow '< 0 so no intersection' o.e.; allow '-4 so no roots' etc</p> <p>allow A2 for full argument from sum of two squares = 0; A1 for weaker correct conclusion</p> <p>some may use the condition $b^2 < 4ac$ for no real roots; allow equivalent marks, with first A1 for $64 < 68$ o.e.</p> |
| <p>10 (i)</p> <p>grad CD = $\frac{5-3}{3-(-1)} \left[= \frac{2}{4} \text{ o.e.} \right]$ isw</p> <p>grad AB = $\frac{3-(-1)}{6-(-2)}$ or $\frac{4}{8}$ isw</p> <p>same gradient so parallel www</p> | | <p>M1</p> <p>M1</p> <p>A1</p> | <p>NB needs to be obtained independently of grad AB</p> <p>must be explicit conclusion mentioning 'same gradient' or 'parallel'</p> <p>if M0, allow B1 for 'parallel lines have same gradient' o.e.</p> |
| <p>10 (ii)</p> <p>[$BC^2 =$] $3^2 + 2^2$ [$BC^2 =$] 13 showing $AD^2 = 1^2 + 4^2 [= 17]$ [$\neq BC^2$] isw</p> | | <p>M1</p> <p>A1</p> <p>A1</p> | <p>accept $(6 - 3)^2 + (3 - 5)^2$ o.e. or [BC =] $\sqrt{13}$ or [AD =] $\sqrt{17}$</p> <p>or equivalent marks for finding AD or AD^2 first</p> <p>alt method: showing $AC \neq BD$ – mark equivalently</p> |

| | | | |
|----------|---|--|---|
| 10 (iii) | <p>[BD eqn is] $y = 3$</p> <p>eqn of AC is $y - 5 = 6/5 \times (x - 3)$ o.e [$y = 1.2x + 1.4$ o.e.]</p> <p>M is $(4/3, 3)$ o.e. isw</p> | <p>M1</p> <p>M2</p> <p>A1</p> | <p>eg allow for 'at M, $y = 3$' or for 3 subst in eqn of AC</p> <p>or M1 for grad AC = $6/5$ o.e. (accept unsimplified) and M1 for using their grad of AC with coords of A(-2, -1) or C (3, 5) in eqn of line or M1 for 'stepping' method to reach M</p> <p>allow : at M, $x = 16/12$ o.e. [eg =$4/3$] isw A0 for 1.3 without a fraction answer seen</p> |
| 10 (iv) | <p>midpt of BD = $(5/2, 3)$ or equivalent simplified form cao</p> <p>midpt AC = $(1/2, 2)$ or equivalent simplified form cao or 'M is $2/3$ of way from A to C'</p> <p>conclusion 'neither diagonal bisects the other'</p> | <p>M1</p> <p>M1</p> <p>A1</p> | <p>or showing $BM \neq MD$ oe [$BM = 14/3, MD = 7/3$]</p> <p>or showing $AM \neq MC$ or $AM^2 \neq MC^2$</p> <p>in these methods A1 is dependent on coords of M having been obtained in part (iii) or in this part; the coordinates of M need not be correct; it is also dependent on midpts of both AC and BD attempted, at least one correct</p> <p>alt method: show that mid point of BD does not lie on AC (M1) and vice-versa (M1), A1 for both and conclusion</p> |

| | | | |
|-----------------|---|--|--|
| 11 (i) | centre $C' = (3, -2)$ radius 5 | 1 1 | 0 for ± 5 or -5 |
| 11 (ii) | showing $(6 - 3)^2 + (-6 + 2)^2 = 25$ showing that $\overrightarrow{AC'} = \overrightarrow{C'B} = \begin{pmatrix} -3 \\ 4 \end{pmatrix}$ o.e. | B1 B2 | interim step needed or B1 each for two of: showing midpoint of $AB = (3, -2)$; showing $B(0, 2)$ is on circle; showing $AB = 10$ or B2 for showing midpoint of $AB = (3, -2)$ and saying this is centre of circle or B1 for finding eqn of AB as $y = -4/3x + 2$ o.e. and B1 for finding one of its intersections with the circle is $(0, 2)$ or B1 for showing $C'B = 5$ and B1 for showing $AB = 10$ or that AC' and BC' have the same gradient or B1 for showing that AC' and BC' have the same gradient and B1 for showing that $B(0, 2)$ is on the circle |
| 11 (iii) | grad AC' or $AB = -4/3$ o.e. grad $tgt = -1/\text{their } AC'$ grad $y - (-6) = \text{their } m(x - 6)$ o.e. $y = 0.75x - 10.5$ o.e. isw | M1 M1 M1 A1 | or ft from their C' , must be evaluated may be seen in eqn for tgt ; allow M2 for grad $tgt = 3/4$ oe soi as first step or M1 for $y = \text{their } m \times x + c$ then subst $(6, -6)$ eg A1 for $4y = 3x - 42$ allow B4 for correct equation www isw |
| 11 (iv) | centre C is at $(12, -14)$ cao circle is $(x - 12)^2 + (y + 14)^2 = 100$ | B2 B1 | B1 for each coord ft their C if at least one coord correct |

| | | | |
|-----------------|--|---|--|
| 12 (i) | 10 | 1 | |
| 12 (ii) | [x =] 5 or ft their (i) $\div 2$ ht = 5[m] cao | 1 1 | not necessarily ft from (i) eg they may start again with calculus to get $x = 5$ |
| 12 (iii) | $d = 7/2$ o.e. [y =] $1/5 \times 3.5 \times (10 - 3.5)$ o.e. or ft = $91/20$ o.e. cao isw | M1 M1 A1 | or ft their (ii) $- 1.5$ or their (i) $\div 2 - 1.5$ o.e. or $7 - 1/5 \times 3.5^2$ or ft or showing $y - 4 = 11/20$ o.e. cao |
| 12 (iv) | $4.5 = 1/5 \times x(10 - x)$ o.e. $22.5 = x(10 - x)$ o.e. $2x^2 - 20x + 45 [= 0]$ o.e. eg $x^2 - 10x + 22.5 [= 0]$ or $(x - 5)^2 = 2.5$ $[x =] \frac{20 \pm \sqrt{40}}{4}$ or $5 \pm \frac{1}{2}\sqrt{10}$ o.e. width = $\sqrt{10}$ o.e. eg $2\sqrt{2.5}$ cao | M1 M1 A1 M1 A1 | eg $4.5 = x(2 - 0.2x)$ etc cao; accept versions with fractional coefficients of x^2 , isw or $x - 5 = [\pm]\sqrt{2.5}$ o.e.; ft their quadratic eqn provided at least M1 gained already; condone one error in formula or substitution; need not be simplified or be real accept simple equivalents only |

4752 (C2) Concepts for Advanced Mathematics

| | | | | | |
|---|------|---|--------------------------------|---|---|
| 1 | | $\frac{1}{2}x^2 + 3x^{-1} + c$ o.e. | 3 | 1 for each term | 3 |
| 2 | (i) | 5 with valid method | 1 | eg sequence has period of 4 nos. | 3 |
| | (ii) | 165 www | 2 | M1 for $13 \times (1 + 3 + 5 + 3) + 1 + 3 + 5$ or for $14 \times (1 + 3 + 5 + 3) - 3$ | |
| 3 | | rt angled triangle with $\sqrt{2}$ on one side and 3 on hyp Pythag. used to obtain remaining side $= \sqrt{7}$ $\tan \theta = \frac{\text{opp}}{\text{adj}} = \frac{\sqrt{2}}{\sqrt{7}}$ o.e. | 1 1 1 | or M1 for $\cos^2 \theta = 1 - \sin^2 \theta$ used A1 for $\cos \theta = \frac{\sqrt{7}}{\sqrt{9}}$ A1 for $\tan \theta = \frac{\sin \theta}{\cos \theta} = \frac{\sqrt{2}}{\sqrt{7}}$ o.e. | 3 |
| 4 | | radius = 6.5 [cm] | 3 | M1 for $\frac{1}{2} \times r^2 \times 0.4$ [= 8.45] o.e. and M1 for $r^2 = \frac{169}{4}$ o.e. [= 42.25] | 3 |
| 5 | (i) | sketch of correct shape with P (-0.5,2) Q (0,4) and R (2,2) | 2 | 1 if Q and one other are correct | 4 |
| | (ii) | sketch of correct shape with P (-1,0.5) Q (0,1) and R (4,0.5) | 2 | 1 if Q and one other are correct | |
| 6 | (i) | 205 | 3 | M1 for AP identified with $d = 4$ and M1 for $5 + 50d$ used | 5 |
| | (ii) | $\frac{25}{3}$ o.e. | 2 | M1 for $r = \frac{2}{5}$ o.e. | |
| 7 | (i) | $\frac{\sin A}{5.6} = \frac{\sin 79}{8.4}$ s.o.i. [A =] 40.87 to 41 | M1 A1 | | 5 |
| | (ii) | [BC ² =] $5.6^2 + 7.8^2 - 2 \times 5.6 \times 7.8 \times$ \cos ("180-79") = 108.8 to 108.9 [BC =] 10.4(...) | M1 A1 A1 | | |
| 8 | | $y' = 3x^{-\frac{1}{2}}$ $\frac{3}{4}$ when $x = 16$ $y = 24$ when $x = 16$ $y - \text{their } 24 = \text{their } \frac{3}{4}(x - 16)$ $y - 24 = \frac{3}{4}(x - 16)$ o.e. | M1 A1 B1 M1 A1 | condone if unsimplified dependent on $\frac{dy}{dx}$ used for m | 5 |

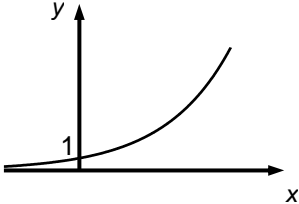
| | | | | | |
|----|-------|---|----------------------------------|--|---|
| 9 | (i) |  | G1 DG1 | for curve of correct shape in both quadrants must go through (0, 1) shown | |
| | (ii) | $2x + 1 = \frac{\log 10}{\log 13}$ o.e. $[x =] 0.55$ | M1 A2 | or M1 for $2x + 1 = \log_3 10$ A1 for other versions of 0.547...or 0.548 | 5 |
| 10 | (i) | $3x^2 - 6x - 9$ use of their $y' = 0$ $x = -1$ $x = 3$ valid method for determining nature of turning point max at $x = -1$ and min at $x = 3$ | M1 M1 A1 A1 M1 A1 | c.a.o. | 6 |
| | (ii) | $x(x^2 - 3x - 9)$ $\frac{3 \pm \sqrt{45}}{2}$ or $(x - \frac{3}{2})^2 = 9 + \frac{9}{4}$ $0, \frac{3}{2} \pm \frac{\sqrt{45}}{2}$ o.e. | M1 M1 A1 | | 3 |
| | (iii) | sketch of cubic with two turning points correct way up x-intercepts – negative, 0, positive shown | G1 DG1 | | 2 |
| 11 | (i) | $47.625 [m^2]$ to 3 sf or more, with correct method shown | 4 | M3 for $\frac{1.5}{2} \times (2.3 + 2 + 2[2.7 + 3.3 + 4 + 4.8 + 5.2 + 5.2 + 4.4])$ | 4 |
| | (ii) | 43.05 | 2 | M1 for $1.5 \times (2.3 + 2.7 + 3.3 + 4 + 4.8 + 5.2 + 4.4 + 2)$ | 2 |
| | (iii) | $-0.013x^4/4 + 0.16x^3/3 - 0.082x^2/2 + 2.4x$ o.e. their integral evaluated at $x = 12$ (and 0) only 47.6 to 47.7 | M2 M1 A1 | M1 for three terms correct dep on integration attempted | 4 |
| | (iv) | 5.30.. found compared with 5.2 s.o.i. | 1 D1 | | 2 |
| 12 | (i) | $\log P = \log a + bt$ www comparison with $y = mx + c$ s.o.i. intercept = $\log_{10} a$ | 1 1 1 | must be with correct equation dependent on correct equation | 3 |
| | (ii) | $[2.12, 2.21], 2.32, 2.44, 2.57, 2.69$ plots ft ruled line of best fit | 1 1 1 | Between (10, 2.08) and (10, 2.12) | 3 |

| | | | | |
|--|---|-------------------------------|--|----------|
| | <p>(iii) $0.0100 \leq m < 0.0125$</p> <p>$a = 10^c$ or $\log a = c$</p> <p>$P = 10^c \times 10^{mt}$ or 10^{m^t+c}</p> | <p>B2</p> <p>B1</p> <p>B1</p> | <p>M1 for $\frac{y\text{-step}}{x\text{-step}}$</p> <p>$1.96 \leq c \leq 2.02$</p> <p>f.t. their m and a</p> | <p>4</p> |
| | <p>(iv) use of $t = 105$</p> <p>1.0 – 2.0 billion approx</p> <p>unreliable since extrapolation o.e.</p> | <p>B1</p> <p>B1</p> <p>E1</p> | | <p>3</p> |

4753 (C3) Methods for Advanced Mathematics

| | | |
|--|--|--|
| <p>1 $e^{2x} - 5e^x = 0$ $\Rightarrow e^x (e^x - 5) = 0$ $\Rightarrow e^x = 5$ $\Rightarrow x = \ln 5$ or 1.6094</p> | <p>M1 M1 A1 A1 [4]</p> | <p>factoring out e^x or dividing $e^{2x} = 5e^x$ by e^x $e^{2x} / e^x = e^x$ $\ln 5$ or 1.61 or better, mark final answer -1 for additional solutions, e.g. $x = 0$</p> |
| <p>or $\ln(e^{2x}) = \ln(5e^x)$ $\Rightarrow 2x = \ln 5 + x$ $\Rightarrow x = \ln 5$ or 1.6094</p> | <p>M1 A1 A1 A1 [4]</p> | <p>taking lns on $e^{2x} = 5e^x$ $2x, \ln 5 + x$ $\ln 5$ or 1.61 or better, mark final answer -1 for additional solutions, e.g. $x = 0$</p> |
| <p>2 (i) When $t = 0, T = 100$ $\Rightarrow 100 = 20 + b$ $\Rightarrow b = 80$ When $t = 5, T = 60$ $\Rightarrow 60 = 20 + 80 e^{-5k}$ $\Rightarrow e^{-5k} = 1/2$ $\Rightarrow k = \ln 2 / 5 = 0.139$</p> | <p>M1 A1 M1 A1 [4]</p> | <p>substituting $t = 0, T = 100$ cao substituting $t = 5, T = 60$ $1/5 \ln 2$ or 0.14 or better</p> |
| <p>(ii) $50 = 20 + 80 e^{-kt}$ $\Rightarrow e^{-kt} = 3/8$ $\Rightarrow t = \ln(8/3) / k = 7.075$ mins</p> | <p>M1 A1 [2]</p> | <p>Re-arranging and taking lns correctly – ft their b and k answers in range 7 to 7.1</p> |
| <p>3(i) $\frac{dy}{dx} = \frac{1}{3}(1+3x^2)^{-2/3} \cdot 6x$ $= 2x(1+3x^2)^{-2/3}$</p> | <p>M1 B1 A1 [3]</p> | <p>chain rule $1/3 u^{-2/3}$ or $\frac{1}{3}(1+3x^2)^{-2/3}$ o.e but must be '2' (not 6/3) mark final answer</p> |
| <p>(ii) $3y^2 \frac{dy}{dx} = 6x$ $\Rightarrow dy/dx = 6x/3y^2$ $= \frac{2x}{(1+3x^2)^{2/3}} = 2x(1+3x^2)^{-2/3}$</p> | <p>M1 A1 A1 E1 [4]</p> | <p>$3y^2 \frac{dy}{dx}$ $= 6x$ if deriving $2x(1+3x^2)^{-2/3}$, needs a step of working</p> |

| | | |
|---|-----------------------------------|---|
| 4(i) $\int_0^1 \frac{2x}{x^2+1} dx = [\ln(x^2+1)]_0^1$ $= \ln 2$ | M2 A1 [3] | $[\ln(x^2+1)]$ cao (must be exact) |
| <i>or</i> let $u = x^2 + 1$, $du = 2x dx$ $\Rightarrow \int_0^1 \frac{2x}{x^2+1} dx = \int_1^2 \frac{1}{u} du$ $= [\ln u]_1^2$ $= \ln 2$ | M1 A1 A1 [3] | $\int \frac{1}{u} du$ or $[\ln(1+x^2)]_0^1$ with correct limits cao (must be exact) |
| (ii) $\int_0^1 \frac{2x}{x+1} dx = \int_0^1 \frac{2x+2-2}{x+1} dx = \int_0^1 (2 - \frac{2}{x+1}) dx$ $= [2x - 2\ln(x+1)]_0^1$ $= 2 - 2\ln 2$ | M1 A1, A1 A1 A1 [5] | dividing by $(x+1)$ 2, $-2/(x+1)$ |
| <i>or</i> $\int_0^1 \frac{2x}{x+1} dx$ let $u = x + 1$, $\Rightarrow du = dx$ $= \int_1^2 \frac{2(u-1)}{u} du$ $= \int_1^2 (2 - \frac{2}{u}) du$ $= [2u - 2\ln u]_1^2$ $= 4 - 2\ln 2 - (2 - 2\ln 1)$ $= 2 - 2\ln 2$ | M1 B1 M1 A1 A1 [5] | substituting $u = x + 1$ and $du = dx$ (or $du/dx = 1$) and correct limits used for u or x $2(u-1)/u$ dividing through by u $2u - 2\ln u$ allow ft on $(u-1)/u$ (i.e. with 2 omitted) o.e. cao (must be exact) |
| 5 (i) $a = 0, b = 3, c = 2$ | B(2,1,0) | or $a = 0, b = -3, c = -2$ |
| (ii) $a = 1, b = -1, c = 1$ or $a = 1, b = 1, c = -1$ | B(2,1,0) [4] | |
| 6 $f(-x) = -f(x), g(-x) = g(x)$ $g f(-x) = g[-f(x)]$ $= g f(x)$ \Rightarrow $g f$ is even | B1B1 M1 E1 [4] | condone f and g interchanged forming $gf(-x)$ or $gf(x)$ and using $f(-x) = -f(x)$ www |
| 7 Let $\arcsin x = \theta$ $\Rightarrow x = \sin \theta$ $\theta = \arccos y \Rightarrow y = \cos \theta$ $\sin^2 \theta + \cos^2 \theta = 1$ $\Rightarrow x^2 + y^2 = 1$ | M1 M1 E1 [3] | |

| | | |
|--|---|---|
| <p>8(i) At P, $x \cos 3x = 0$ $\Rightarrow \cos 3x = 0$ $\Rightarrow 3x = \pi/2, 3\pi/2$ $\Rightarrow x = \pi/6, \pi/2$ So P is $(\pi/6, 0)$ and Q is $(\pi/2, 0)$</p> | <p>M1 M1 A1 A1 [4]</p> | <p>or verification $3x = \pi/2, (3\pi/2...)$ dep both Ms condone degrees here</p> |
| <p>(ii) $\frac{dy}{dx} = -3x \sin 3x + \cos 3x$</p> <p>At P, $\frac{dy}{dx} = -\frac{\pi}{2} \sin \frac{\pi}{2} + \cos \frac{\pi}{2} = -\frac{\pi}{2}$</p> <p>At TPs $\frac{dy}{dx} = -3x \sin 3x + \cos 3x = 0$ $\Rightarrow \cos 3x = 3x \sin 3x$ $\Rightarrow 1 = 3x \sin 3x / \cos 3x = 3x \tan 3x$ $\Rightarrow x \tan 3x = 1/3$ *</p> | <p>M1 B1 A1 M1 A1cao M1 E1 [7]</p> | <p>Product rule $d/dx (\cos 3x) = -3 \sin 3x$ cao (so for $dy/dx = -3x \sin 3x$ allow B1) mark final answer substituting their $-\pi/6$ (must be rads) $-\pi/2$ $dy/dx = 0$ and $\sin 3x / \cos 3x = \tan 3x$ used www</p> |
| <p>(iii) $A = \int_0^{\pi/6} x \cos 3x dx$</p> <p>Parts with $u = x, dv/dx = \cos 3x$ $du/dx = 1, v = 1/3 \sin 3x$</p> <p>$\Rightarrow A = \left[\frac{1}{3} x \sin 3x \right]_0^{\pi/6} - \int_0^{\pi/6} \frac{1}{3} \sin 3x dx$</p> <p>$= \left[\frac{1}{3} x \sin 3x + \frac{1}{9} \cos 3x \right]_0^{\pi/6}$</p> <p>$= \frac{\pi}{18} - \frac{1}{9}$</p> | <p>B1 M1 A1 A1 M1dep A1 cao [6]</p> | <p>Correct integral and limits (soi) – ft their P, but must be in radians</p> <p>can be without limits</p> <p>dep previous A1. substituting correct limits, dep 1st M1: ft their P provided in radians o.e. but must be exact</p> |

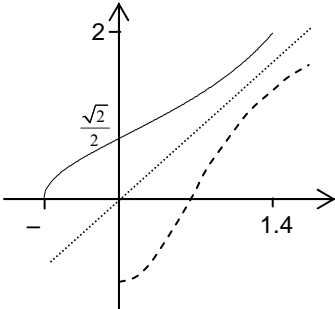
| | | |
|--|---|---|
| <p>9(i) $f'(x) = \frac{(x^2+1)4x - (2x^2-1)2x}{(x^2+1)^2}$ $= \frac{4x^3+4x-4x^3+2x}{(x^2+1)^2} = \frac{6x}{(x^2+1)^2}$ *</p> <p>When $x > 0$, $6x > 0$ and $(x^2+1)^2 > 0$ $\Rightarrow f'(x) > 0$</p> | <p>M1 A1 E1</p> <p>M1 E1</p> <p>[5]</p> | <p>Quotient or product rule correct expression www</p> <p>attempt to show or solve $f'(x) > 0$ numerator > 0 and denominator > 0 or, if solving, $6x > 0 \Rightarrow x > 0$</p> |
| <p>(ii) $f(2) = \frac{8-1}{4+1} = 1\frac{2}{5}$</p> <p>Range is $-1 \leq y \leq 1\frac{2}{5}$</p> | <p>B1</p> <p>B1 [2]</p> | <p>must be \leq, y or $f(x)$</p> |
| <p>(iii) $f'(x)$ max when $f''(x) = 0$ $\Rightarrow 6 - 18x^2 = 0$ $\Rightarrow x^2 = 1/3, x = 1/\sqrt{3}$ $\Rightarrow f'(x) = \frac{6/\sqrt{3}}{(1/\sqrt{3})^2} = \frac{6}{\sqrt{3}} \cdot \frac{9}{16} = \frac{9\sqrt{3}}{8} = 1.95$</p> | <p>M1 A1 M1 A1 [4]</p> | <p>(\pm)$1/\sqrt{3}$ oe (0.577 or better) substituting $1/\sqrt{3}$ into $f'(x)$ $9\sqrt{3}/8$ o.e. or 1.95 or better (1.948557..)</p> |
| <p>(iv) Domain is $-1 < x < 1\frac{2}{5}$ Range is $0 \leq y \leq 2$</p>  | <p>B1</p> <p>B1</p> <p>M1 A1 cao</p> <p>[4]</p> | <p>fit their 1.4 but not $x \geq -1$</p> <p>or $0 \leq g(x) \leq 2$ (not f)</p> <p>Reasonable reflection in $y = x$ from $(-1, 0)$ to $(1.4, 2)$, through $(0, \sqrt{2}/2)$ allow omission of one of $-1, 1.4, 2, \sqrt{2}/2$</p> |
| <p>(v) $y = \frac{2x^2-1}{x^2+1} \quad x \leftrightarrow y$ $x = \frac{2y^2-1}{y^2+1}$</p> <p>$\Rightarrow xy^2 + x = 2y^2 - 1$ $\Rightarrow x + 1 = 2y^2 - xy^2 = y^2(2 - x)$ $\Rightarrow y^2 = \frac{x+1}{2-x}$ $\Rightarrow y = \sqrt{\frac{x+1}{2-x}}$ *</p> | <p>M1 M1 M1</p> <p>E1 [4]</p> | <p>(could start from g)</p> <p>Attempt to invert clearing fractions collecting terms in y^2 and factorising</p> <p>www</p> |

4754 (C4) Applications of Advanced Mathematics

| | | | | |
|---|-----|---|---|---|
| 1 | | $\frac{1+2x}{(1-2x)^2} = (1+2x)(1-2x)^{-2}$ $= (1+2x)\left[1 + (-2)(-2x) + \frac{(-2)(-3)}{1.2}(-2x)^2 + \dots\right]$ $= (1+2x)[1 + 4x + 12x^2 + \dots]$ $= 1 + 4x + 12x^2 + 2x + 8x^2 + \dots$ $= 1 + 6x + 20x^2 + \dots$ <p>Valid for $-1 < -2x < 1$ $\Rightarrow -\frac{1}{2} < x < \frac{1}{2}$</p> | M1 A1 A1 M1 A1 M1 A1 [7] | binomial expansion power -2 unsimplified, correct sufficient terms |
| 2 | | $\tan 2\theta = \frac{2 \tan \theta}{1 - \tan^2 \theta}$ $\Rightarrow \cot 2\theta = \frac{1}{\tan 2\theta} = \frac{1 - \tan^2 \theta}{2 \tan \theta} *$ $\cot 2\theta = 1 + \tan \theta$ $\Rightarrow \frac{1 - \tan^2 \theta}{2 \tan \theta} = 1 + \tan \theta$ $\Rightarrow 1 - \tan^2 \theta = 2 \tan \theta + 2 \tan^2 \theta$ $\Rightarrow 3 \tan^2 \theta + 2 \tan \theta - 1 = 0$ $\Rightarrow (3 \tan \theta - 1)(\tan \theta + 1) = 0$ $\Rightarrow \tan \theta = 1/3, \theta = 18.43^\circ, 198.43^\circ$ $\text{or } \tan \theta = -1, \theta = 135^\circ, 315^\circ$ | M1 E1 M1 M1 A3,2,1, 0 [7] | oe eg converting either side into a one line fraction(s) involving $\sin \theta$ and $\cos \theta$. quadratic = 0 factorising or solving 18.43°, 198.43°, 135°, 315° -1 extra solutions in the range |
| 3 | (i) | $\frac{dy}{dt} = \frac{(1+t).2 - 2t.1}{(1+t)^2} = \frac{2}{(1+t)^2}$ $\frac{dx}{dt} = 2e^{2t}$ $\frac{dy}{dx} = \frac{dy/dt}{dx/dt}$ $\Rightarrow \frac{dy}{dx} = \frac{\frac{2}{(1+t)^2}}{2e^{2t}} = \frac{1}{e^{2t}(1+t)^2}$ $t = 0 \Rightarrow dy/dx = 1$ | M1A1 B1 M1 A1 B1ft [6] | |

| | | | | |
|---|------|---|---|--|
| | (ii) | $2t = \ln x \Rightarrow t = \frac{1}{2} \ln x$ $\Rightarrow y = \frac{\ln x}{1 + \frac{1}{2} \ln x} = \frac{2 \ln x}{2 + \ln x}$ | M1 A1 [2] | or t in terms of y |
| 4 | (i) | $\overline{AB} = \begin{pmatrix} -2 \\ -1 \\ -1 \end{pmatrix}, \overline{AC} = \begin{pmatrix} -1 \\ -11 \\ 3 \end{pmatrix}$ | B1 B1 [2] | |
| | (ii) | $\mathbf{n} \cdot \overline{AB} = \begin{pmatrix} 2 \\ -1 \\ -3 \end{pmatrix} \cdot \begin{pmatrix} -2 \\ -1 \\ -1 \end{pmatrix} = -4 + 1 + 3 = 0$ $\mathbf{n} \cdot \overline{AC} = \begin{pmatrix} 2 \\ -1 \\ -3 \end{pmatrix} \cdot \begin{pmatrix} -1 \\ -11 \\ 3 \end{pmatrix} = -2 + 11 - 9 = 0$ $\Rightarrow \text{plane is } 2x - y - 3z = d$ $x = 1, y = 3, z = -2 \Rightarrow d = 2 - 3 + 6 = 5$ $\Rightarrow \text{plane is } 2x - y - 3z = 5$ | M1 E1 E1 M1 A1 [5] | scalar product |
| 5 | (i) | $x = -5 + 3\lambda = 1 \Rightarrow \lambda = 2$ $y = 3 + 2 \times 0 = 3$ $z = 4 - 2 = 2, \text{ so } (1, 3, 2) \text{ lies on 1st line.}$ $x = -1 + 2\mu = 1 \Rightarrow \mu = 1$ $y = 4 - 1 = 3$ $z = 2 + 0 = 2, \text{ so } (1, 3, 2) \text{ lies on 2}^{\text{nd}} \text{ line.}$ | M1 E1 E1 [3] | finding λ or μ verifying two other coordinates for line 1 verifying two other coordinates for line 2 |
| | (ii) | $\text{Angle between } \begin{pmatrix} 3 \\ 0 \\ -1 \end{pmatrix} \text{ and } \begin{pmatrix} 2 \\ -1 \\ 0 \end{pmatrix}$ $\cos \theta = \frac{3 \times 2 + 0 \times (-1) + (-1) \times 0}{\sqrt{10} \sqrt{5}}$ $= 0.8485 \dots$ $\Rightarrow \theta = 31.9^\circ$ | M1 M1 A1 A1 [4] | direction vectors only allow M1 for any vectors or 0.558 radians |

| | | | | |
|---|-------|--|--|---|
| 6 | (i) | $\begin{aligned} \text{BAC} &= 120 - 90 - (90 - \theta) \\ &= \theta - 60 \\ \Rightarrow \text{BC} &= b \sin(\theta - 60) \\ \text{CD} &= \text{AE} = a \sin \theta \\ \Rightarrow h &= \text{BC} + \text{CD} = a \sin \theta + b \sin(\theta - 60^\circ) * \end{aligned}$ | B1 M1 E1 [3] | |
| | (ii) | $\begin{aligned} h &= a \sin \theta + b \sin(\theta - 60^\circ) \\ &= a \sin \theta + b(\sin \theta \cos 60 - \cos \theta \sin 60) \\ &= a \sin \theta + \frac{1}{2} b \sin \theta - \frac{\sqrt{3}}{2} b \cos \theta \\ &= \left(a + \frac{1}{2} b\right) \sin \theta - \frac{\sqrt{3}}{2} b \cos \theta * \end{aligned}$ | M1 M1 E1 [3] | corr compound angle formula $\sin 60 = \sqrt{3}/2$, $\cos 60 = 1/2$ used |
| | (iii) | $\begin{aligned} \text{OB horizontal when } h &= 0 \\ \Rightarrow \left(a + \frac{1}{2} b\right) \sin \theta - \frac{\sqrt{3}}{2} b \cos \theta &= 0 \\ \Rightarrow \left(a + \frac{1}{2} b\right) \sin \theta &= \frac{\sqrt{3}}{2} b \cos \theta \\ \Rightarrow \frac{\sin \theta}{\cos \theta} &= \frac{\frac{\sqrt{3}}{2} b}{a + \frac{1}{2} b} \\ \Rightarrow \tan \theta &= \frac{\sqrt{3} b}{2a + b} * \end{aligned}$ | M1 M1 E1 [3] | $\frac{\sin \theta}{\cos \theta} = \tan \theta$ |
| | (iv) | $\begin{aligned} 2 \sin \theta - \sqrt{3} \cos \theta &= R \sin(\theta - \alpha) \\ &= R(\sin \theta \cos \alpha - \cos \theta \sin \alpha) \\ \Rightarrow R \cos \alpha &= 2, R \sin \alpha = \sqrt{3} \\ \Rightarrow R^2 &= 2^2 + (\sqrt{3})^2 = 7, R = \sqrt{7} = 2.646 \text{ m} \\ \tan \alpha &= \sqrt{3}/2, \alpha = 40.9^\circ \\ \text{So } h &= \sqrt{7} \sin(\theta - 40.9^\circ) \\ \Rightarrow h_{\max} &= \sqrt{7} = 2.646 \text{ m} \\ &\text{when } \theta - 40.9^\circ = 90^\circ \\ \Rightarrow \theta &= 130.9^\circ \end{aligned}$ | M1 B1 M1A1 B1ft M1 A1 [7] | |

| | | | | |
|---|-------|--|--|---|
| 7 | (i) | $\frac{dx}{dt} = -1(1+e^{-t})^{-2} \cdot -e^{-t}$ $= \frac{e^{-t}}{(1+e^{-t})^2}$ $1-x = 1 - \frac{1}{1+e^{-t}}$ $1-x = \frac{1+e^{-t}-1}{1+e^{-t}} = \frac{e^{-t}}{1+e^{-t}}$ $\Rightarrow x(1-x) = \frac{1}{1+e^{-t}} \frac{e^{-t}}{1+e^{-t}} = \frac{e^{-t}}{(1+e^{-t})^2}$ $\Rightarrow \frac{dx}{dt} = x(1-x)$ <p>When $t = 0$, $x = \frac{1}{1+e^0} = 0.5$</p> | M1 A1 M1 A1 E1 B1 [6] | chain rule substituting for $x(1-x)$ $1-x = \frac{1+e^{-t}-1}{1+e^{-t}} = \frac{e^{-t}}{1+e^{-t}}$ [OR, M1 A1 for solving differential equation for t , B1 use of initial condition, M1 A1 making x the subject, E1 required form] |
| | (ii) | $\frac{1}{(1+e^{-t})} = \frac{3}{4}$ $\Rightarrow e^{-t} = 1/3$ $\Rightarrow t = -\ln 1/3 = 1.10 \text{ years}$ | M1 M1 A1 [3] | correct log rules |
| | (iii) | $\frac{1}{x^2(1-x)} = \frac{A}{x^2} + \frac{B}{x} + \frac{C}{1-x}$ $\Rightarrow 1 = A(1-x) + Bx(1-x) + Cx^2$ $x = 0 \Rightarrow A = 1$ $x = 1 \Rightarrow C = 1$ $\text{coefft of } x^2: 0 = -B + C \Rightarrow B = 1$ | M1 M1 B(2,1,0) [4] | clearing fractions substituting or equating coeffs for A,B or C $A = 1, B = 1, C = 1$ www |
| | (iv) | $\int \frac{dx}{x^2(1-x)} = \int dt$ $\Rightarrow t = \int \left(\frac{1}{x^2} + \frac{1}{x} + \frac{1}{1-x} \right) dx$ $= -1/x + \ln x - \ln(1-x) + c$ <p>When $t = 0$, $x = 1/2 \Rightarrow 0 = -2 + \ln 1/2 - \ln 1/2 + c$</p> $\Rightarrow c = 2.$ $\Rightarrow t = -1/x + \ln x - \ln(1-x) + 2$ $= 2 + \ln \frac{x}{1-x} - \frac{1}{x} *$ | M1 B1 B1 M1 E1 [5] | separating variables $-1/x + \dots$ $\ln x - \ln(1-x)$ ft their A,B,C substituting initial conditions |
| | (v) | $t = 2 + \ln \frac{3/4}{1-3/4} - \frac{1}{3/4} = \ln 3 + \frac{2}{3} = 1.77 \text{ yrs}$ | M1A1 [2] | |

| | | | |
|----------------------------|--|--------------------------|-------------------------------|
| 1 | 15 | B1 | |
| 2 | THE MATHEMATICIAN | B1 | |
| 3 | M H X I Q 3 or 4 correct – award 1 mark | B2 | |
| 4 | Two from Ciphertext N has high frequency E would then correspond to ciphertext R which also has high frequency T would then correspond to ciphertext G which also has high frequency A is preceded by a string of six letters displaying low frequency | B1 B1 | oe oe |
| 5 | The length of the keyword is a factor of both 84 and 40. The <u>only</u> common factors of 84 and 40 are 1,2 and 4 (and a keyword of length 1 can be dismissed in this context) | M1 E1 | |
| 6 | Longer strings to analyse so letter frequency more transparent. Or there are fewer 2-letter keywords to check | B2 | |
| 7 | OQH DRR EBG One or two accurate – award 1 mark | B2 | |
| 8 (i) (ii) (iii) | Evidence of intermediate H FACE Evidence of intermediate HCEG – award 2 marks Evidence of accurate application of one of the two decoding ciphers - award 1 mark $800 = (3 \times 266) + 2$; the second row gives T so plaintext is R | B1 B3 M1 A1 | Use of second row |

4755 (FP1) Further Concepts for Advanced Mathematics

| | | | |
|-------|--|--|--|
| 1 | $\alpha\beta = (-3+j)(5-2j) = -13+11j$ $\frac{\alpha}{\beta} = \frac{-3+j}{5-2j} = \frac{(-3+j)(5+2j)}{29} = \frac{-17}{29} - \frac{1}{29}j$ | M1 A1 [2] | Use of $j^2 = -1$ |
| 2 (i) | AB is impossible $CA = (50)$ $B + D = \begin{pmatrix} 3 & 1 \\ 6 & -2 \end{pmatrix}$ $AC = \begin{pmatrix} 20 & 4 & 32 \\ -10 & -2 & -16 \\ 20 & 4 & 32 \end{pmatrix}$ | B1 B1 B1 B2 [5] | -1 each error |
| | (ii) | | |
| 3 | $\alpha + \beta + \gamma = a - d + a + a + d = \frac{12}{4} \Rightarrow a = 1$ $(a-d)a(a+d) = \frac{3}{4} \Rightarrow d = \pm \frac{1}{2}$ <p>So the roots are $\frac{1}{2}$, 1 and $\frac{3}{2}$</p> $\alpha\beta + \alpha\gamma + \beta\gamma = \frac{k}{4} = \frac{11}{4} \Rightarrow k = 11$ | M1 A1 M1 A1 M1 A1 [6] | Valid attempt to use sum of roots $a = 1$, c.a.o. Valid attempt to use product of roots All three roots Valid attempt to use $\alpha\beta + \alpha\gamma + \beta\gamma$, or to multiply out factors, or to substitute a root $k = 11$ c.a.o. |

| | | | |
|---|--|---|---|
| 4 | $\mathbf{MM}^{-1} = \frac{1}{k} \begin{pmatrix} 4 & 0 & 1 \\ -6 & 1 & 1 \\ 5 & 2 & 5 \end{pmatrix} \begin{pmatrix} -3 & -2 & 1 \\ -35 & -15 & 10 \\ 17 & 8 & -4 \end{pmatrix}$ $= \frac{1}{k} \begin{pmatrix} 5 & 0 & 0 \\ 0 & 5 & 0 \\ 0 & 0 & 5 \end{pmatrix} \Rightarrow k = 5$ $\begin{pmatrix} x \\ y \\ z \end{pmatrix} = \frac{1}{5} \begin{pmatrix} -3 & -2 & 1 \\ -35 & -15 & 10 \\ 17 & 8 & -4 \end{pmatrix} \begin{pmatrix} 9 \\ 32 \\ 81 \end{pmatrix}$ $\frac{1}{5} \begin{pmatrix} -3 & -2 & 1 \\ -35 & -15 & 10 \\ 17 & 8 & -4 \end{pmatrix} \begin{pmatrix} 9 \\ 32 \\ 81 \end{pmatrix} = \frac{1}{5} \begin{pmatrix} -10 \\ 15 \\ 85 \end{pmatrix}$ $\Rightarrow x = -2, y = 3, z = 17$ | <p>M1</p> <p>A1 [2]</p> <p>M1</p> <p>M1</p> <p>A1</p> <p>A1 [4]</p> | <p>Attempt to consider \mathbf{MM}^{-1} or $\mathbf{M}^{-1}\mathbf{M}$ (may be implied)</p> <p>c.a.o.</p> <p>Attempt to pre-multiply by \mathbf{M}^{-1}</p> <p>Attempt to multiply matrices</p> <p>Correct</p> <p>All 3 correct s.c. B1 if matrices not used</p> |
| 5 | $\sum_{r=1}^n (r+2)(r-3) = \sum_{r=1}^n (r^2 - r - 6)$ $= \sum_{r=1}^n r^2 - \sum_{r=1}^n r - 6n$ $= \frac{1}{6}n(n+1)(2n+1) - \frac{1}{2}n(n+1) - 6n$ $= \frac{1}{6}n[(n+1)(2n+1) - 3(n+1) - 36]$ $= \frac{1}{6}n(2n^2 - 38) = \frac{1}{3}n(n^2 - 19)$ | <p>M1</p> <p>A2</p> <p>M1</p> <p>A1</p> <p>A1 [6]</p> | <p>Separate into 3 sums</p> <p>-1 each error</p> <p>Valid attempt to factorise (with n as a factor)</p> <p>Correct expression c.a.o.</p> <p>Complete, convincing argument</p> |
| 6 | <p>When $n = 1$, $\frac{n(n+1)(n+2)}{3} = 2$,</p> <p>so true for $n = 1$</p> <p>Assume true for $n = k$</p> $2 + 6 + \dots + k(k+1) = \frac{k(k+1)(k+2)}{3}$ $\Rightarrow 2 + 6 + \dots + (k+1)(k+2)$ $= \frac{k(k+1)(k+2)}{3} + (k+1)(k+2)$ $= \frac{1}{3}(k+1)(k+2)(k+3)$ $= \frac{(k+1)((k+1)+1)((k+1)+2)}{3}$ <p>But this is the given result with $k + 1$ replacing k. Therefore if it is true for $n = k$ it is true for $n = k + 1$.</p> <p>Since it is true for $n = 1$, it is true for $n = 1, 2, 3$ and so true for all positive integers.</p> | <p>B1</p> <p>E1</p> <p>M1</p> <p>A1</p> <p>E1</p> <p>E1 [6]</p> | <p>Assume true for k</p> <p>Add $(k + 1)$th term to both sides</p> <p>c.a.o. with correct simplification</p> <p>Dependent on A1 and previous E1</p> <p>Dependent on B1 and previous E1</p> |

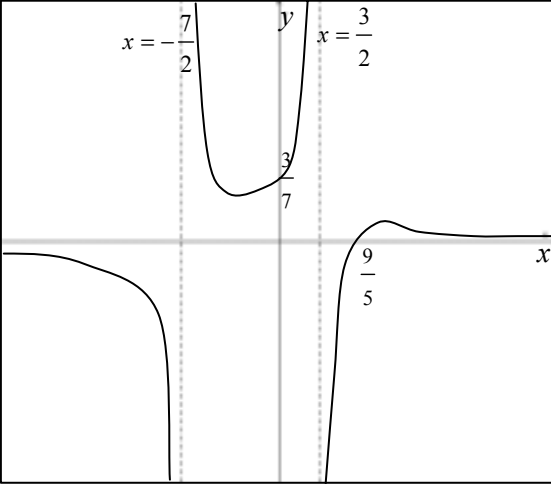
| | | | |
|--------------|---|---------------------------------|--|
| <p>7 (i)</p> | $x = -\frac{7}{2}, x = \frac{3}{2}, y = 0$ | <p>B1 B1 B1 [3]</p> | |
| <p>(ii)</p> | <p>Large positive x, $y \rightarrow 0^+$ (e.g. consider $x = 100$) Large negative x, $y \rightarrow 0^-$ (e.g. consider $x = -100$)</p> | <p>B1 B1 M1 [3]</p> | <p>Evidence of method</p> |
| <p>(iii)</p> |  | <p>B1 B1 B1 [3]</p> | <p>Intercepts correct and labelled LH and central branches correct RH branch correct, with clear maximum</p> |
| <p>(iv)</p> | $x < -\frac{7}{2}$ <p>or</p> $\frac{3}{2} < x \leq \frac{9}{5}$ | <p>B1 B2 [3]</p> | <p>Award B1 if only error relates to inclusive/exclusive inequalities</p> |

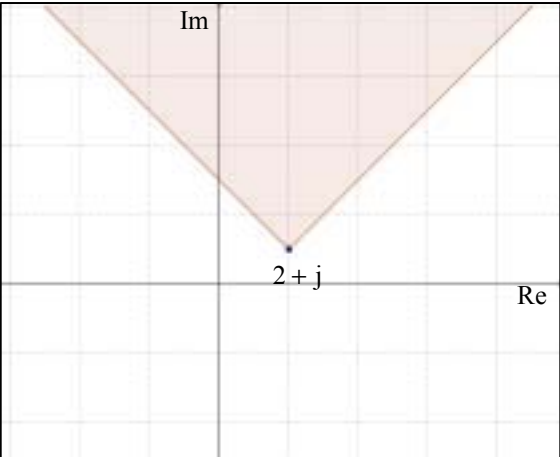
| | | | |
|------------------------|--|--------------------------------------|---|
| <p>8(a) (i)</p> | $ z - (2 + 6j) = 4$ | <p>B1 B1 B1 [3]</p> | <p>$2 + 6j$ seen (expression in z) = 4 Correct equation</p> |
| <p>(ii)</p> | $ z - (2 + 6j) < 4$ and $ z - (3 + 7j) > 1$ | <p>B1 B1 B1 [3]</p> | <p>$z - (2 + 6j) < 4$ $z - (3 + 7j) > 1$ (allow errors in inequality signs) Both inequalities correct</p> |
| <p>(b)(i)</p> |  | <p>B1 B1 B1 [3]</p> | <p>Any straight line through $2 + j$ Both correct half lines Region between their two half lines indicated</p> |
| <p>(ii)</p> | $43 + 47j - (2 + j) = 41 + 46j$ $\arg(41 + 46j) = \arctan\left(\frac{46}{41}\right) = 0.843$ $\frac{\pi}{4} < 0.843 < \frac{3\pi}{4}$ so $43 + 47j$ does fall within the region | <p>M1 A1 E1 [3]</p> | <p>Attempt to calculate argument, or other valid method such as comparison with $y = x - 1$ Correct Justified</p> |

| | | | |
|---------------------|---|---|--|
| <p>9 (i)</p> | $\frac{2}{r} - \frac{3}{r+1} + \frac{1}{r+2}$ $= \frac{2(r+1)(r+2) - 3r(r+2) + r(r+1)}{r(r+1)(r+2)}$ $= \frac{2r^2 + 6r + 4 - 3r^2 - 6r + r^2 + r}{r(r+1)(r+2)} = \frac{4+r}{r(r+1)(r+2)}$ | <p>M1</p> <p>A1</p> <p>[2]</p> | <p>Attempt a common denominator</p> <p>Convincingly shown</p> |
| <p>(ii)</p> | $\sum_{r=1}^n \frac{4+r}{r(r+1)(r+2)} = \sum_{r=1}^n \left[\frac{2}{r} - \frac{3}{r+1} + \frac{1}{r+2} \right]$ $= \left(\frac{2}{1} - \frac{3}{2} + \frac{1}{3} \right) + \left(\frac{2}{2} - \frac{3}{3} + \frac{1}{4} \right) + \left(\frac{2}{3} - \frac{3}{4} + \frac{1}{5} \right) + \dots$ $+ \dots + \left(\frac{2}{n-1} - \frac{3}{n} + \frac{1}{n+1} \right) + \left(\frac{2}{n} - \frac{3}{n+1} + \frac{1}{n+2} \right)$ $= \frac{2}{1} - \frac{3}{2} + \frac{2}{2} - \frac{3}{n+1} + \frac{1}{n+1} - \frac{3}{n+1} + \frac{1}{n+2}$ $= \frac{3}{2} - \frac{2}{n+1} + \frac{1}{n+2} \text{ as required}$ | <p>M1</p> <p>M1</p> <p>A2</p> <p>M1</p> <p>A1</p> <p>[6]</p> | <p>Use of the given result (may be implied)</p> <p>Terms in full (at least first and one other)</p> <p>At least 3 consecutive terms correct, -1 each error</p> <p>Attempt to cancel, including algebraic terms</p> <p>Convincingly shown</p> |
| <p>(iii)</p> | $\frac{3}{2}$ | <p>B1</p> <p>[1]</p> | |
| <p>(iv)</p> | $\sum_{r=50}^{100} \frac{4+r}{r(r+1)(r+2)}$ $= \sum_{r=1}^{100} \frac{4+r}{r(r+1)(r+2)} - \sum_{r=1}^{49} \frac{4+r}{r(r+1)(r+2)}$ $= \left(\frac{3}{2} - \frac{2}{101} + \frac{1}{102} \right) - \left(\frac{3}{2} - \frac{2}{50} + \frac{1}{51} \right)$ $= 0.0104 \text{ (3s.f.)}$ | <p>M1</p> <p>M1</p> <p>A1</p> <p>[3]</p> | <p>Splitting into two parts</p> <p>Use of result from (ii)</p> <p>c.a.o.</p> |

4756 (FP2) Further Methods for Advanced Mathematics

| | | | |
|---------------|--|---|--|
| 1 (a) | $y = \arctan \sqrt{x}$ $u = \sqrt{x}, y = \arctan u$ $\Rightarrow \frac{du}{dx} = \frac{1}{2\sqrt{x}}, \frac{dy}{du} = \frac{1}{1+u^2}$ $\Rightarrow \frac{dy}{dx} = \frac{1}{1+u^2} \times \frac{1}{2\sqrt{x}}$ $= \frac{1}{1+x} \times \frac{1}{2\sqrt{x}} = \frac{1}{2\sqrt{x}(x+1)}$ | M1 A1 A1 | Using Chain Rule Correct derivative in any form Correct derivative in terms of x |
| | OR $\tan y = \sqrt{x}$ $\Rightarrow \sec^2 y \frac{dy}{dx} = \frac{1}{2\sqrt{x}}$ $\sec^2 y = 1 + \tan^2 y = 1 + x$ $\Rightarrow \frac{dy}{dx} = \frac{1}{2\sqrt{x}(x+1)}$ | M1A1 A1 | Rearranging for \sqrt{x} or x and differentiating implicitly |
| | $\Rightarrow \int_0^1 \frac{1}{\sqrt{x}(x+1)} dx = \left[2 \arctan \sqrt{x} \right]_0^1$ $= 2 \arctan 1 - 2 \arctan 0$ $= 2 \times \frac{\pi}{4} = \frac{\pi}{2}$ | M1 A1 A1 (ag) | Integral in form $k \arctan \sqrt{x}$ $k = 2$ |
| (b)(i) | $x = r \cos \theta, y = r \sin \theta, x^2 + y^2 = r^2$ $x^2 + y^2 = xy + 1$ $\Rightarrow r^2 = r^2 \cos \theta \sin \theta + 1$ $\Rightarrow r^2 = \frac{1}{2} r^2 \sin 2\theta + 1$ $\Rightarrow 2r^2 = r^2 \sin 2\theta + 2$ $\Rightarrow r^2(2 - \sin 2\theta) = 2$ $\Rightarrow r^2 = \frac{2}{2 - \sin 2\theta}$ | M1 A1 A1 A1 (ag) | Using at least one of these LHS RHS Clearly obtained SR: $x = r \sin \theta, y = r \cos \theta$ used M1A1A0A0 max. 4 |
| (ii) | Max r is $\sqrt{2}$ Occurs when $\sin 2\theta = 1$ $\Rightarrow \theta = \frac{\pi}{4}, \frac{5\pi}{4}$ Min $r = \frac{\sqrt{2}}{3}$ Occurs when $\sin 2\theta = -1$ $\Rightarrow \theta = \frac{3\pi}{4}, \frac{7\pi}{4}$ | B1 M1 A1 B1 M1 A1 | Attempting to solve Both. Accept degrees. A0 if extras in range $\frac{\sqrt{6}}{3}$ Attempting to solve (must be -1) Both. Accept degrees. A0 if extras in range 6 |

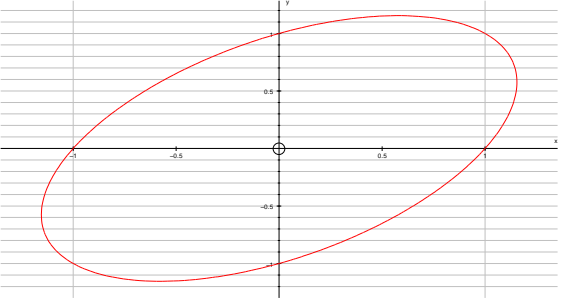
| | | | |
|-------|---|--|--|
| (iii) |  | <p>G1</p> <p>G1</p> <p>2</p> | <p>Closed curve, roughly elliptical, with no points or dents</p> <p>Major axis along $y = x$</p> <p>18</p> |
| 2 (a) | $\cos 5\theta + j \sin 5\theta = (\cos \theta + j \sin \theta)^5$ $= \cos^5 \theta + 5 \cos^4 \theta j \sin \theta + 10 \cos^3 \theta j^2 \sin^2 \theta$ $+ 10 \cos^2 \theta j^3 \sin^3 \theta + 5 \cos \theta j^4 \sin^4 \theta + j^5 \sin^5 \theta$ $= \cos^5 \theta - 10 \cos^3 \theta \sin^2 \theta + 5 \cos \theta \sin^4 \theta + j(\dots)$ $\cos 5\theta = \cos^5 \theta - 10 \cos^3 \theta \sin^2 \theta + 5 \cos \theta \sin^4 \theta$ $= \cos^5 \theta - 10 \cos^3 \theta (1 - \cos^2 \theta) + 5 \cos \theta (1 - \cos^2 \theta)^2$ $= 16 \cos^5 \theta - 20 \cos^3 \theta + 5 \cos \theta$ | <p>M1</p> <p>M1</p> <p>A1</p> <p>M1</p> <p>M1</p> <p>A1</p> <p>6</p> | <p>Using de Moivre</p> <p>Using binomial theorem appropriately</p> <p>Correct real part. Must evaluate powers of j</p> <p>Equating real parts</p> <p>Replacing $\sin^2 \theta$ by $1 - \cos^2 \theta$</p> <p>$a = 16, b = -20, c = 5$</p> |
| (b) | <p>$C + jS$</p> $= e^{j0} + e^{j\left(\theta + \frac{2\pi}{n}\right)} + \dots + e^{j\left(\theta + \frac{(2n-2)\pi}{n}\right)}$ <p>This is a G.P.</p> $a = e^{j\theta}, r = e^{j\frac{2\pi}{n}}$ $\text{Sum} = \frac{e^{j\theta} \left(1 - \left(e^{j\frac{2\pi}{n}} \right)^n \right)}{1 - e^{j\frac{2\pi}{n}}}$ <p>Numerator = $e^{j\theta} (1 - e^{2\pi j})$ and $e^{2\pi j} = 1$</p> <p>so sum = 0</p> <p>$\Rightarrow C = 0$ and $S = 0$</p> | <p>M1</p> <p>A1</p> <p>M1</p> <p>A1</p> <p>A1</p> <p>E1</p> <p>E1</p> <p>7</p> | <p>Forming series $C + jS$ as exponentials</p> <p>Need not see whole series</p> <p>Attempting to sum finite or infinite G.P.</p> <p>Correct a, r used or stated, and n terms</p> <p>Must see j</p> <p>Convincing explanation that sum = 0</p> <p>$C = S = 0$. Dep. on previous E1</p> <p>Both E marks dep. on 5 marks above</p> |
| (c) | $e^t \approx 1 + t + \frac{1}{2}t^2$ $\frac{t}{e^t - 1} \approx \frac{t}{t + \frac{1}{2}t^2}$ $\frac{t}{t + \frac{1}{2}t^2} = \frac{1}{1 + \frac{1}{2}t} = \left(1 + \frac{1}{2}t\right)^{-1} = 1 - \frac{1}{2}t + \dots$ <p>OR $\frac{1}{1 + \frac{1}{2}t} = \frac{1}{1 + \frac{1}{2}t} \times \frac{1 - \frac{1}{2}t}{1 - \frac{1}{2}t} = \frac{1 - \frac{1}{2}t}{1 - \frac{1}{4}t^2}$</p> <p>Hence $\frac{t}{e^t - 1} \approx 1 - \frac{1}{2}t$</p> <p>OR $(e^t - 1)\left(1 - \frac{1}{2}t\right) = \left(t + \frac{1}{2}t^2 + \dots\right)\left(1 - \frac{1}{2}t\right)$</p> $\approx t + \text{terms in } t^3$ <p>$\Rightarrow \frac{t}{e^t - 1} \approx 1 - \frac{1}{2}t$</p> | <p>B1</p> <p>M1</p> <p>A1</p> <p>M1</p> <p>M1</p> <p>A1 (ag)</p> <p>M1</p> <p>A1</p> <p>M1</p> <p>A1</p> <p>5</p> | <p>Ignore terms in higher powers</p> <p>Substituting Maclaurin series</p> <p>Suitable manipulation and use of binomial theorem</p> <p>Substituting Maclaurin series</p> <p>Correct expression</p> <p>Multiplying out</p> <p>Convincing explanation</p> <p>18</p> |

| | | |
|---|---|---|
| <p>3 (i)</p> $\mathbf{M}^{-1} = \frac{1}{4-a} \begin{pmatrix} 2 & -2-2a & 2+a \\ 2 & 2-3a & 2a-2 \\ -1 & 5 & -3 \end{pmatrix}$ <p>When $a = -1$, $\mathbf{M}^{-1} = \frac{1}{5} \begin{pmatrix} 2 & 0 & 1 \\ 2 & 5 & -4 \\ -1 & 5 & -3 \end{pmatrix}$</p> | <p>M1 A1 M1 A1 M1</p> <p>A1</p> | <p>Evaluating determinant $4 - a$ Finding at least four cofactors Six signed cofactors correct Transposing and dividing by det</p> <p>\mathbf{M}^{-1} correct (in terms of a) and result for $a = -1$ stated</p> <p>SR: After 0 scored, SC1 for \mathbf{M}^{-1} when $a = -1$, obtained correctly with some working</p> <p>6</p> |
| <p>(ii)</p> $\begin{pmatrix} x \\ y \\ z \end{pmatrix} = \frac{1}{5} \begin{pmatrix} 2 & 0 & 1 \\ 2 & 5 & -4 \\ -1 & 5 & -3 \end{pmatrix} \begin{pmatrix} -2 \\ b \\ 1 \end{pmatrix}$ <p>$\Rightarrow x = -\frac{3}{5}, y = b - \frac{8}{5}, z = b - \frac{1}{5}$</p> <p>OR $4x + y = b - 4$ $x - y = 1 - b$ o.e.</p> <p>$\Rightarrow x = -\frac{3}{5}$</p> <p>$\Rightarrow y = b - \frac{8}{5}, z = b - \frac{1}{5}$</p> | <p>M2</p> <p>M1</p> <p>A2</p> <p>M1</p> <p>M1</p> <p>A1</p> <p>M1</p> <p>A1</p> | <p>Attempting to multiply $(-2 \ b \ 1)^T$ by given matrix (M0 if wrong order)</p> <p>Multiplying out</p> <p>A1 for one correct</p> <p>Eliminating one unknown in 2 ways Or e.g. $3x + z = b - 2, 5x = -3$ Or e.g. $3y - 4z = -b - 4, 5y - 5z = -7$ Solve to obtain one value. Dep. on M1 above One unknown correct After M0, SC1 for value of x Finding the other two unknowns</p> <p>Both correct</p> <p>5</p> |
| <p>(iii) e.g. $3x - 3y = 2b + 2$ $5x - 5y = 4$</p> <p>Consistent if $\frac{2b+2}{3} = \frac{4}{5}$</p> <p>$\Rightarrow b = \frac{1}{5}$</p> <p>Solution is a line</p> | <p>M1 A1A1</p> <p>M1</p> <p>A1</p> <p>B2</p> | <p>Eliminating one unknown in 2 ways Two correct equations Or e.g. $3x + 6z = b - 2, 5x + 10z = -3$ Or e.g. $3y + 6z = -b - 4, 5y + 10z = -7$</p> <p>Attempting to find b</p> <p>7</p> |

| | | | |
|----------|---|---|--|
| 4 (i) | $\sinh x = \frac{e^x - e^{-x}}{2} \Rightarrow \sinh^2 x = \frac{(e^x - e^{-x})^2}{4}$ $= \frac{e^{2x} - 2 + e^{-2x}}{4}$ $\Rightarrow 2 \sinh^2 x + 1 = \frac{e^{2x} - 2 + e^{-2x}}{2} + 1$ $= \frac{e^{2x} + e^{-2x}}{2} = \cosh 2x$ $\Rightarrow 2 \sinh 2x = 4 \sinh x \cosh x$ $\Rightarrow \sinh 2x = 2 \sinh x \cosh x$ | B1 B1 B1 B1 | $e^{2x} - 2 + e^{-2x}$ Correct completion Both correct derivatives Correct completion |
| 4 | | | |
| (ii) | $2 \cosh 2x + 3 \sinh x = 3$ $\Rightarrow 2(1 + 2 \sinh^2 x) + 3 \sinh x = 3$ $\Rightarrow 4 \sinh^2 x + 3 \sinh x - 1 = 0$ $\Rightarrow (4 \sinh x - 1)(\sinh x + 1) = 0$ $\Rightarrow \sinh x = \frac{1}{4}, -1$ $\Rightarrow x = \operatorname{arsinh}\left(\frac{1}{4}\right) = \ln\left(\frac{1 + \sqrt{17}}{4}\right)$ $x = \operatorname{arsinh}(-1) = \ln(-1 + \sqrt{2})$ | M1 A1 M1 A1 M1 A1 | Using identity Correct quadratic Solving quadratic Both Use of $\operatorname{arsinh} x = \ln(x + \sqrt{x^2 + 1})$ o.e. Must obtain at least one value of x Must evaluate $\sqrt{x^2 + 1}$ |
| OR | $2e^{4x} + 3e^{3x} - 6e^{2x} - 3e^x + 2 = 0$ $\Rightarrow (2e^{2x} - e^x - 2)(e^{2x} + 2e^x - 1) = 0$ $\Rightarrow e^x = \frac{1 \pm \sqrt{17}}{4} \text{ or } -1 \pm \sqrt{2}$ $\Rightarrow x = \ln\left(\frac{1 + \sqrt{17}}{4}\right) \text{ or } \ln(-1 + \sqrt{2})$ | M1A1 M1A1 M1A1A1 | Factorising quartic Solving either quadratic Using ln (dependent on first M1) |
| 7 | | | |
| (iii) | $\cosh t = \frac{5}{4} \Rightarrow \frac{e^t + e^{-t}}{2} = \frac{5}{4}$ $\Rightarrow 2e^{2t} - 5e^t + 2 = 0$ $\Rightarrow (2e^t - 1)(e^t - 2) = 0$ $\Rightarrow e^t = \frac{1}{2}, 2$ $\Rightarrow t = \pm \ln 2$ $\int_4^5 \frac{1}{\sqrt{x^2 - 16}} dx = \left[\operatorname{arcosh} \frac{x}{4} \right]_4^5$ $= \operatorname{arcosh} \frac{5}{4} - \operatorname{arcosh} 1$ $= \ln 2$ | M1 M1 A1 A1 (ag) B1 M1 A1 | Forming quadratic in e^t Solving quadratic Convincing working Substituting limits A0 for $\pm \ln 2$ |
| OR | $\int_4^5 \frac{1}{\sqrt{x^2 - 16}} dx = \left[\ln(x + \sqrt{x^2 - 16}) \right]_4^5$ $= \ln 8 - \ln 4$ $= \ln 2$ | B1 M1 A1 | Substituting limits |
| 7 | | | |
| | | | 18 |

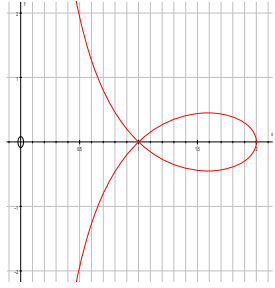
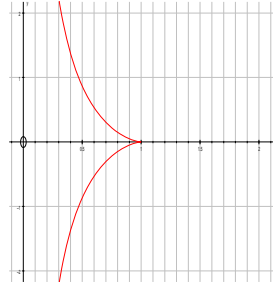
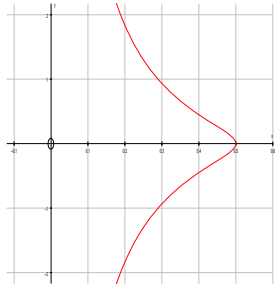
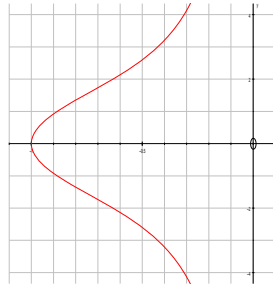
| | | | |
|--|---|--|---|
| <p>5 (i)</p> | <p>Horz. projection of QP = $k \cos \theta$ Vert. projection of QP = $k \sin \theta$ Subtract OQ = $\tan \theta$</p> | <p>B1 B1 B1 3</p> | <p>Clearly obtained</p> |
| <p>(ii)</p> | <div style="display: flex; flex-wrap: wrap;"> <div style="width: 50%; text-align: center;"> <p>$k = 2$</p>  </div> <div style="width: 50%; text-align: center;"> <p>$k = 1$</p>  </div> <div style="width: 50%; text-align: center;"> <p>$k = 1/2$</p>  </div> <div style="width: 50%; text-align: center;"> <p>$k = -1$</p>  </div> </div> | <p>G1 G1 G1 G1 4</p> | <p>Loop Cusp</p> |
| <p>(iii)(A) (B) (C)</p> | <p>for all k, y axis is an asymptote $k = 1$ $k > 1$</p> | <p>B1 B1 B1 3</p> | <p>Both</p> |
| <p>(iv)</p> | <p>Crosses itself at $(1, 0)$ $k = 2 \Rightarrow \cos \theta = \frac{1}{2} \Rightarrow \theta = 60^\circ$ \Rightarrow curve crosses itself at 120°</p> | <p>M1 A1 2</p> | <p>Obtaining a value of θ Accept 240°</p> |
| <p>(v)</p> | <p>$y = 8 \sin \theta - \tan \theta$ $\Rightarrow \frac{dy}{d\theta} = 8 \cos \theta - \sec^2 \theta$ $\Rightarrow 8 \cos \theta - \frac{1}{\cos^2 \theta} = 0$ at highest point $\Rightarrow \cos^3 \theta = \frac{1}{8} \Rightarrow \cos \theta = \pm \frac{1}{2} \Rightarrow \theta = 60^\circ$ at top $\Rightarrow x = 4$ $y = 3\sqrt{3}$</p> | <p>M1 A1 A1 3</p> | <p>Complete method giving θ Both</p> |
| <p>(vi)</p> | <p>RHS = $\frac{(k \cos \theta - 1)^2}{k^2 \cos^2 \theta} (k^2 - k^2 \cos^2 \theta)$ $= \frac{(k \cos \theta - 1)^2}{k^2 \cos^2 \theta} \times k^2 \sin^2 \theta$ $= (k \cos \theta - 1)^2 \tan^2 \theta$ $= ((k \cos \theta - 1) \tan \theta)^2$ $= (k \sin \theta - \tan \theta)^2 = \text{LHS}$</p> | <p>M1 M1 E1 3</p> | <p>Expressing one side in terms of θ Using trig identities</p> |

4758 Differential Equations

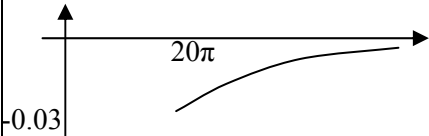
| | | | | |
|-------|--|---|---|----------|
| 1(i) | $\alpha^2 + 6\alpha + 9 = 0$ $\alpha = -3$ (repeated) $y = e^{-3t} (A + Bt)$ PI $y = a \sin t + b \cos t$ $\dot{y} = a \cos t - b \sin t$ $\ddot{y} = -a \sin t - b \cos t$ $-a \sin t - b \cos t + 6(a \cos t - b \sin t)$ $\quad + 9(a \sin t + b \cos t) = 0.5 \sin t$ $8a - 6b = 0.5$ $8b + 6a = 0$ Solving gives $a = 0.04, b = -0.03$ GS $y = e^{-3t} (A + Bt) + 0.04 \sin t - 0.03 \cos t$ | M1 A1 F1 B1 M1 M1 M1 A1 F1 | Auxiliary equation CF for their roots Differentiate twice and substitute Compare coefficients Solve PI + CF with two arbitrary constants | 9 |
| (ii) | $t = 0, y = 0 \Rightarrow A = 0.03$ $\dot{y} = e^{-3t} (B - 3A - 3Bt) + 0.04 \cos t + 0.03 \sin t$ $t = 0, \dot{y} = 0 \Rightarrow 0 = B - 3A + 0.04$ $y = 0.01(e^{-3t} (3 + 5t) + 4 \sin t - 3 \cos t)$ | M1 M1 F1 M1 A1 | Use condition Differentiate Follows their GS Use condition Cao | 5 |
| (iii) | For large t , the particle oscillates With amplitude constant (≈ 0.05) | B1 B1 | Oscillates Amplitude approximately constant | 2 |
| (iv) | $t = 20\pi \Rightarrow e^{-60\pi}$ very small $y \approx -0.03$ $\dot{y} \approx 0.04$ | M1 A1 A1 | | 3 |
| (v) | $y = e^{-3t} (C + Dt)$  | M1 A1 B1 ✓ B1 B1 | CF of correct type or same type as in (i) Must use new arbitrary constants $y \approx -0.03$ at $t = 20\pi$ Gradient at 20π consistent with (iv) Shape consistent | 5 |

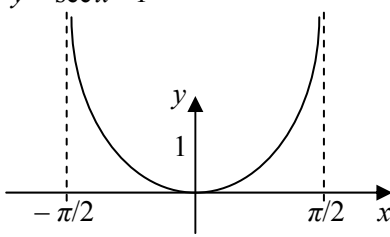
| | | | |
|----------------|---|--|----------|
| 2(a)(i) | $I = \exp \int -\tan x \, dx$ $= \exp(-\ln \sec x)$ $= (\sec x)^{-1} = \cos x$ $\cos x \frac{dy}{dx} - y \sin x = \sin x$ $\frac{d}{dx}(y \cos x) = \sin x$ $y \cos x = -\cos x + A$ $(y = A \sec x - 1)$ | M1 Attempt IF A1 Correct IF A1 Simplified M1 Multiply by IF M1 Recognise derivative M1 Integrate A1 RHS (including constant) A1 LHS | 8 |
| | $\frac{dy}{dx} = (1+y) \tan x$ $\ln(1+y) = \ln \sec x + A$ | M1 Rearrange equation A1 M1 Separate variables A1 M1 RHS A1 M1 LHS A1 | 8 |
| (ii) | $x = 0, y = 0 \Rightarrow 0 = A - 1$ $y = \sec x - 1$  | M1 Use condition A1 B1 Shape and through origin B1 Behaviour at $\pm \frac{1}{2}\pi$ | 4 |
| (b)(i) | | M1 Attempt one curve A1 Reasonable attempt at one curve M1 Attempt second curve A1 Reasonable attempt at both curves | 4 |
| (ii) | $y' = (1 + y^2) \tan x$ $x = 0, y = 1 \Rightarrow y' = 0$ $y(0.1) = 1 + 0.1 \times 0 = 1$ $x = 0.1, y = 1 \Rightarrow y' = 0.201$ $y(0.2) = 1 + 0.1 \times 0.201$ $= 1.0201$ | M1 Rearrange M1 Use of algorithm A1 M1 Use of algorithm for second step E1 | 5 |
| (iii) | $\tan \frac{\pi}{2} \text{ undefined so cannot go past } \frac{\pi}{2}$ $\text{So approximation cannot continue to } 1.6 > \frac{\pi}{2}$ | M1 A1 | 2 |
| (iv) | Reduce step length | B1 | 1 |

| | | | |
|--------------|--|---|-----------|
| 3(i) | $\dot{x} = Ae^{-kt}$ $t = 0, \dot{x} = v_1 \Rightarrow A = v_1$ $\dot{x} = v_1 e^{-kt}$ $x = \int v_1 e^{-kt} dt$ $= -\frac{v_1}{k} e^{-kt} + B$ $t = 0, x = 0 \Rightarrow B = \frac{v_1}{k}$ $x = \frac{v_1}{k} (1 - e^{-kt})$ | M1 Any valid method (or no method shown) A1 M1 Use condition A1 M1 Integrate A1 M1 Use condition E1 | 8 |
| (ii) | $\int \frac{dy}{y + g/k} = \int -k dt$ $\ln\left(y + \frac{g}{k}\right) = -kt + C$ $y + \frac{g}{k} = De^{-kt}$ $t = 0, y = v_2 \Rightarrow D = v_2 + \frac{g}{k}$ $y = \left(v_2 + \frac{g}{k}\right) e^{-kt} - \frac{g}{k}$ $y = \int \left[\left(v_2 + \frac{g}{k}\right) e^{-kt} - \frac{g}{k}\right] dt$ $= -\frac{1}{k} \left(v_2 + \frac{g}{k}\right) e^{-kt} - \frac{g}{k} t + E$ $t = 0, y = 0 \Rightarrow 0 = -\frac{1}{k} \left(v_2 + \frac{g}{k}\right) + E$ $y = \frac{1}{k^2} (kv_2 + g)(1 - e^{-kt}) - \frac{g}{k} t$ | M1 Separate and integrate A1 LHS A1 RHS M1 Rearrange, dealing properly with constant M1 Use condition A1 M1 Integrate A1 M1 Use condition E1 | 10 |
| (iii) | $1 - e^{-kt} = \frac{kx}{v_1}$ $t = -\frac{1}{k} \ln\left(1 - \frac{kx}{v_1}\right)$ $y = \left(\frac{kv_2 + g}{kv_1}\right) x + \frac{g}{k^2} \ln\left(1 - \frac{kx}{v_1}\right)$ | M1 A1 M1 Substitute E1 Convincingly shown | 4 |
| (iv) | $x = 8 \Rightarrow y = 4.686$ Hence will not clear wall | M1 A1 | 2 |

| | | | | |
|--------------|--|---|---|---|
| 4(i) | $4y = -3x + 23 - \dot{x}$ $4\dot{y} = -3\dot{x} - \ddot{x}$ $\frac{1}{4}(-3\dot{x} - \ddot{x}) = 2x + \frac{1}{4}(-3x + 23 - \dot{x}) - 7$ $-3\dot{x} - \ddot{x} = 8x - 3x + 23 - \dot{x} - 28$ $\Rightarrow \ddot{x} + 2\dot{x} + 5x = 5$ | M1 M1 M1 M1 E1 | y or $4y$ in terms of x, \dot{x} Differentiate Substitute for y Substitute for \dot{y} | 5 |
| (ii) | $\alpha^2 + 2\alpha + 5 = 0$ $\Rightarrow \alpha = -1 \pm 2i$ CF $e^{-t}(A \cos 2t + B \sin 2t)$ PI $x = \frac{5}{5} = 1$ GS $x = 1 + e^{-t}(A \cos 2t + B \sin 2t)$ | M1 A1 M1 F1 B1 B1 F1 | Auxiliary equation CF for complex roots CF for their roots Constant PI Correct PI PI + CF with two arbitrary constants | 7 |
| (iii) | $y = \frac{1}{4}(-3x + 23 - \dot{x})$ $= \frac{1}{4} \left[-3 - 3e^{-t}(A \cos 2t + B \sin 2t) + 23 \right.$ $\quad \left. + e^{-t}(A \cos 2t + B \sin 2t) - e^{-t}(-2A \sin 2t + 2B \cos 2t) \right]$ $y = 5 - \frac{1}{2}e^{-t}((A+B)\cos 2t + (B-A)\sin 2t)$ | M1 M1 F1 A1 | Differentiate and substitute Expression for \dot{x} follows their GS | 4 |
| (iv) | $t = 0, x = 8 \Rightarrow 1 + A = 8 \Rightarrow A = 7$ $t = 0, y = 0 \Rightarrow 5 - \frac{1}{2}(A + B) = 0 \Rightarrow B = 3$ $x = 1 + e^{-t}(7 \cos 2t + 3 \sin 2t)$ $y = 5 - e^{-t}(5 \cos 2t - 2 \sin 2t)$ | M1 M1 A1 A1 | Use condition Use condition | 4 |
| (v) | For large t , e^{-t} tends to 0 $y \rightarrow 5$ $x \rightarrow 1$ $\Rightarrow y > x$ | M1 B1 B1 E1 | Complete argument | 4 |

4761 Mechanics 1

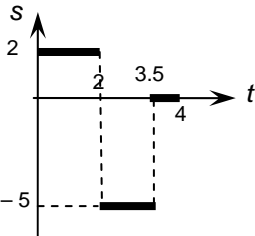
| | | | | |
|-------|---|--|--|---|
| 1 (i) | $0 < t < 2, v = 2$ $2 < t < 3.5, v = -5$ | B1 B1 | Condone '5 downwards' and '-5 downwards' | 2 |
| (ii) |  | B1 B1 | <p>Condone intent – e.g. straight lines free-hand and scales not labelled; accept non-vertical sections at $t = 2$ & 3.5.</p> <p>Only horizontal lines used and 1st two parts present. BOD t-axis section. One of 1st 2 sections correct. FT (i) and allow if answer correct with (i) wrong All correct. Accept correct answer with (i) wrong. FT (i) only if 2nd section –ve in (i)</p> | 2 |
| (iii) | (A) upwards; (B) and (C) downwards | E1 | All correct. Accept +/- ve but not towards/away from O Accept forwards/backwards. Condone additional wrong statements about position. | 1 |
| 5 | | | | |
| 2 (i) | $\begin{pmatrix} 12 \\ 9 \end{pmatrix} = \begin{pmatrix} 2 \\ -3 \end{pmatrix} + 4\mathbf{a}$ so $\mathbf{a} = \begin{pmatrix} 2.5 \\ 3 \end{pmatrix}$ | M1 A1 | Use of $\mathbf{v} = \mathbf{u} + \mathbf{a}t$ If vector \mathbf{a} seen, isw. | 2 |
| (ii) | either $\mathbf{r} = \begin{pmatrix} -1 \\ 2 \end{pmatrix} + \begin{pmatrix} 2 \\ -3 \end{pmatrix} \times 4 + \frac{1}{2} \mathbf{a} \times 4^2$ $\mathbf{r} = \begin{pmatrix} 27 \\ 14 \end{pmatrix} \text{ so } \begin{pmatrix} 27 \\ 14 \end{pmatrix} \text{ m}$ or | M1 A1 A1 M1 A1 A1 | For use of $\mathbf{s} = \mathbf{u}t + \frac{1}{2}\mathbf{a}t^2$ with their a . Initial position may be omitted. FT their a . Initial position may be omitted. cao. Do not condone magnitude as final answer. Use of $\mathbf{s} = 0.5t(\mathbf{u} + \mathbf{v})$ Initial position may be omitted. Correct substitution. Initial position may be omitted. cao Do not condone mag as final answer. SC2 for $\begin{pmatrix} 28 \\ 12 \end{pmatrix}$ | 3 |

| | | | | |
|--------------|--|--------------------------|---|--------|
| (iii) | Using N2L $\mathbf{F} = 5\mathbf{a} = \begin{pmatrix} 12.5 \\ 15 \end{pmatrix}$ so $\begin{pmatrix} 12.5 \\ 15 \end{pmatrix}$ N | M1 F1 | Use of $\mathbf{F} = m\mathbf{a}$ or $\mathbf{F} = m\mathbf{g}\mathbf{a}$. FT their a only. Do not accept magnitude as final ans. | 2 7 |
| 3 (i) | $ \mathbf{F} = \sqrt{(-1)^2 + 5^2}$ $= \sqrt{26} = 5.0990\dots = 5.10$ (3 s. f.) Angle with \mathbf{j} is $\arctan(0.2)$ so $11.309\dots$ so 11.3° (3 s. f.) | M1 A1 M1 A1 | Accept $\sqrt{-1^2 + 5^2}$ even if taken to be $\sqrt{24}$ accept $\arctan(p)$ where $p = \pm 0.2$ or ± 5 o.e. cao | 4 |
| (ii) | $\begin{pmatrix} -2 \\ 3b \end{pmatrix} = 4\begin{pmatrix} -1 \\ 5 \end{pmatrix} + \begin{pmatrix} 2a \\ a \end{pmatrix}$ $a = 1, b = 7$ so $\mathbf{G} = \begin{pmatrix} 2 \\ 1 \end{pmatrix}$ and $\mathbf{H} = \begin{pmatrix} -2 \\ 21 \end{pmatrix}$ or $\mathbf{G} = 2\mathbf{i} + \mathbf{j}$ and $\mathbf{H} = -2\mathbf{i} + 21\mathbf{j}$ | M1 M1 A1 A1 | $\mathbf{H} = 4\mathbf{F} + \mathbf{G}$ soi Formulating at least 1 scalar equation from their vector equation soi a correct or G follows from their wrong a \mathbf{H} cao | 4 8 |
| 4(i) | $20\cos 15 = 19.3185\dots$ so 19.3 N (3 s. f.) in direction BC | B1 | Accept no direction. Must be evaluated | 1 |
| (ii) | Let the tension be T $T \sin 50 = 19.3185\dots$ so $T = 25.2185\dots$ so 25.2 N (3 s. f.) | M1 F1 | Accept $\sin \leftrightarrow \cos$ but not $(i) \times \sin 50$ FT their $19.3\dots$ only. cwo | 2 |
| (iii) | $R + 20 \sin 15 - 2.5g - 25.2185\dots \times \cos 50 = 0$ $R = 35.5337\dots$ so 35.5 N (3 s. f.) | M1 B1 A1 A1 | Allow 1 force missing or 1 tension not resolved. FT T . No extra forces. Accept mass used. Accept $\sin \leftrightarrow \cos$. Weight correct All correct except sign errors. FT their T cao. Accept 35 or 36 for 2. s.f. | 4 |
| (iv) | The horizontal resolved part of the 20 N force is not changed. | E1 | Accept no reference to vertical component but do not accept 'no change' to both components. No need to be explicit that value of tension in AB depends only on horizontal component of force at C | 1 |
| | | | | 8 |

| | | | | |
|-------|--|----------------------------------|--|---|
| 5(i) | $a = 6t - 12$ | M1 A1 | Differentiating cao | 2 |
| (ii) | We need $\int_1^3 (3t^2 - 12t + 14) dt$ $= [t^3 - 6t^2 + 14t]_1^3$ either $= (27 - 54 + 42) - (1 - 6 + 14)$ $= 15 - 9 = 6$ so 6 m or $s = t^3 - 6t^2 + 14t + C$ $s = 0$ when $t = 1$ gives $0 = 1 - 6 + 14 + C$ so $C = -9$ Put $t = 3$ to give $s = 27 - 54 + 42 - 9 = 6$ so 6 m. | M1 A1 M1 A1 M1 A1 | Integrating. Neglect limits. At least two terms correct. Neglect limits. Dep on 1 st M1. Use of limits with attempt at subtraction seen. cao Dep on 1 st M1. An attempt to find C using $s(1) = 0$ and then evaluating $s(3)$. cao | 4 |
| (iii) | $v > 0$ so the particle always travels in the same (+ve) direction As the particle never changes direction, the final distance from the starting point is the displacement. | E1 E1 | Only award if explicit Complete argument | |
| | | | | 2 |
| | | | | 8 |
| 6 (i) | Component of weight down the plane is $1.5 \times 9.8 \times \frac{2}{7} = 4.2$ N | M1 E1 | Use of mgk where k involves an attempt at resolution Accept $1.5 \times 9.8 \times \frac{2}{7} = 4.2$ or $14.7 \times \frac{2}{7} = 4.2$ seen | 2 |
| (ii) | Down the plane. Take F down the plane. $4.2 - 6.4 + F = 0$ so $F = 2.2$. Friction is 2.2 N down the plane | M1 A1 | Allow sign errors. All forces present. No extra forces. Must have direction. [Award 1 for 2.2 N seen and 2 for 2.2 N down plane seen] | 2 |
| (iii) | F up the plane N2L down the plane $4.2 - F = 1.5 \times 1.2$ so $F = 4.2 - 1.8 = 2.4$ Friction is 2.4 N up the plane | M1 A1 A1 A1 | N2L. $F = ma$. No extra forces. Allow weight term missing or wrong Allow only sign errors ± 2.4 cao. Accept no reference to direction if $F = 2.4$. | 4 |
| (iv) | $2^2 = 0.8^2 + 2 \times 1.2 \times s$ $s = 1.4$ so 1.4 m | M1 A1 A1 | Use of $v^2 = u^2 + 2as$ or sequence All correct in 1 or 2-step method | 3 |

| | | | | |
|-------|--|---|--|----|
| (v) | <p>Diagrams</p> <p>either Up the plane</p> $10 - 3.5 \times 9.8 \times \frac{2}{7} - (2.3 + 0.7) = 3.5a$ <p>$a = -0.8$ so 0.8 m s^{-2}. down the plane For barge B up the plane</p> $T - 2 \times 9.8 \times \frac{2}{7} - 0.7 = 2 \times (-0.8)$ <p>$T = 4.7$ so 4.7 N. Tension or (separate equations of motion)</p> <p>Barge A</p> <p>Barge B</p> <p>$a = -0.8$ so 0.8 m s^{-2}. down the plane $T = 4.7$ so 4.7 N. Tension</p> | <p>B1</p> <p>B1</p> <p>M1</p> <p>B1</p> <p>A1</p> <p>M1</p> <p>A1</p> <p>M1</p> <p>M1</p> <p>M1</p> <p>A1</p> <p>A1</p> | <p>Frictions and coupling force correctly labelled with arrows.</p> <p>All forces present and properly labelled with arrows.</p> <p>N2L. $F = ma$. No extra forces. Condone sign errors. Allow total/part weight or total/part friction omitted (but not both). Allow mass instead of weight and mass/weight not or wrongly resolved.</p> <p>Correct overall mass and friction</p> <p>Clear description or diagram</p> <p>N2L on one barge with their $\pm a$ ($\neq 1.2$ or 0). All forces present and weight component attempted. No extra forces. Condone sign errors.</p> <p>cao In eom for A or B allow weight or friction missing and also allow mass used instead of weight and wt not or wrongly resolved. In other equn weight component attempted and friction term present.</p> <p>N2L. Do not allow $F = mga$. No extra forces. Condone sign errors.</p> <p>N2L. Do not allow $F = mga$. No extra forces. Condone sign errors.</p> <p>Solving a pair of equns in a and T</p> <p>Clear description or diagram</p> <p>cao cwo</p> | |
| | | | | 7 |
| | | | | 18 |
| 7 (i) | $y(0) = 1$ | B1 | | 1 |
| (ii) | <p>Either</p> $\frac{1}{2}(20 + 5) - 5 = 7.5$ <p>or</p> $y(7.5) = \frac{1}{100}(100 + 15 \times 7.5 - 7.5^2)$ $= \frac{25}{16} (1.5625) \text{ so } 1.5625 \text{ m}$ | <p>M1</p> <p>A1</p> <p>A1</p> <p>M1</p> <p>A1</p> <p>A1</p> <p>M1</p> <p>E1</p> | <p>Use of symmetry e.g. use of $\frac{1}{2}(20 + 5)$</p> <p>12.5 o.e. seen</p> <p>7.5 cao</p> <p>Attempt at y' and to solve $y' = 0$</p> <p>$k(15 - 2x)$ where $k = 1$ or $\frac{1}{100}$</p> <p>7.5 cao, seen as final answer</p> <p>FT their 7.5</p> <p>AG [SC2 only showing 1.5625 leads to $x = 7.5$]</p> | 5 |

| | | | | |
|-------|---|--|--|----|
| (iii) | $4.9t^2 = \frac{25}{16}$ (1.5625) $t^2 = 0.31887\dots$ so $t = \pm 0.56469\dots$ Hence 0.565 s (3 s. f.) | M1 A1 E1 | Use of $s = ut + 0.5at^2$ with $u = 0$. Condone use of ± 10 , ± 9.8 , ± 9.81 . If sequence of <i>suvat</i> used, complete method required. In any method only error accepted is sign error AG. Condone no reference to -ve value. www. 0.565 must be justified as answer to 3 s. f. | 3 |
| (iv) | $\dot{x} = \frac{12.5}{0.56469\dots} = 22.1359\dots$ so 22.1 m s ⁻¹ (3 s. f.) Either Time is $\frac{20}{12.5} \times 0.56469\dots$ s so 0.904 s (3 s. f.) or Time is $\frac{20}{22.1359\dots}$ s = 0.903507... so 0.904 s (3 s. f.) or (iii) + $\frac{7.5}{\text{their } \dot{x}}$ so 0.904 s (3 s. f.) | M1 B1 E1 M1 A1 M1 A1 M1 A1 | or 25 / (2×0.56469..) Use of 12.5 or equivalent 22.1 must be justified as answer to 3 s. f. Don't penalise if penalty already given in (iii). cao Accept 0.91 (2 s. f.) cao Accept 0.91 (2 s. f.) cao Accept 0.91 (2 s. f.) | 5 |
| (v) | $v = \sqrt{\dot{x}^2 + \dot{y}^2}$ $\dot{y}^2 = 0^2 + 2 \times 9.8 \times \frac{25}{16}$ or $\dot{y} = 0 + 9.8 \times 0.5646\dots$ = $\frac{245}{8}$ (30.625) or $\dot{y} = \pm 5.539\dots$ so $v = \sqrt{490 + 30.625} = 22.8172\dots$ m s ⁻¹ so 22.8 m s ⁻¹ (3 s. f.) | M1 M1 A1 A1 | Must have attempts at both components Or equiv. $u = 0$. Condone use of ± 10 , ± 9.8 , ± 9.81 . Accept wrong s (or t in alternative method) Or equivalent. May be implied. Could come from (iii) if $v^2 = u^2 + 2as$ used there. Award marks again. cao. www | 4 |
| | | | | 18 |

4762 Mechanics 2

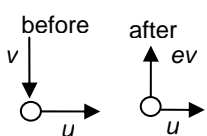
| | | | | |
|----------------------------|---|--|--|----|
| 1 (a) (i) | Let vel of Q be $v \rightarrow$ $6 \times 1 = 4v + 2 \times 4$ $v = -0.5$ so 0.5 m s^{-1} in opposite direction to R | M1 A1 A1 A1 | Use of PCLM Any form Direction must be made clear. Accept -0.5 only if $+ve$ direction clearly shown | 4 |
| (ii) | Let velocities after be R: $v_R \rightarrow$; S: $v_S \rightarrow$ PCLM $+ve \rightarrow 4 \times 2 - 1 \times 3 = 2v_R + 3v_S$ $2v_R + 3v_S = 5$ NEL $+ve \rightarrow$ $\frac{v_S - v_R}{-1-4} = -0.1$ so $v_S - v_R = 0.5$ Solving gives $v_R = 0.7 \rightarrow$ $v_S = 1.2 \rightarrow$ | M1 A1 M1 A1 A1 A1 | PCLM Any form NEL Any form Direction not required Direction not required Award cao for 1 vel and FT second | 6 |
| (iii) | R and S separate at 0.5 m s^{-1} Time to drop T given by $0.5 \times 9.8T^2 = 0.4$ so $T = \frac{2}{7}$ (0.28571...) so distance is $\frac{2}{7} \times 0.5 = \frac{1}{7} \text{ m}$ (0.142857...m) | M1 B1 A1 | FT their result above. Either from NEL or from difference in final velocities cao | 3 |
| (b) |  $u \rightarrow u$ $v \rightarrow (-)ev$ KE loss is $\frac{1}{2}m(u^2 + v^2) - \frac{1}{2}m(u^2 + e^2v^2)$ $= \frac{1}{2}mu^2 + \frac{1}{2}mv^2 - \frac{1}{2}mu^2 - \frac{1}{2}me^2v^2$ $= \frac{1}{2}mv^2(1 - e^2)$ | B1 B1 M1 E1 | Accept $v \rightarrow ev$ Attempt at difference of KEs Clear expansion and simplification of correct expression | 4 |
| | | | | 17 |

| | | | | |
|--------------|---|----------------------------------|--|----|
| 2(i) | <p>GPE is $1200 \times 9.8 \times 60 = 705\,600$ Power is $(705\,600 + 1\,800\,000) \div 120$ $= 20\,880\text{ W} = 20\,900\text{ W}$ (3 s. f.)</p> | B1 M1 B1 A1 | <p>Need not be evaluated power is $WD \div \text{time}$ 120 s cao</p> | 4 |
| (ii) | <p>Using $P = Fv$. Let resistance be R N $13500 = 18F$ so $F = 750$ As v const, $a = 0$ so $F - R = 0$ Hence resistance is 750 N</p> <p>We require $750 \times 200 = 150\,000\text{ J}$ (= 150 kJ)</p> | M1 A1 E1 M1 F1 | <p>Use of $P = Fv$. Needs some justification Use of $WD = Fd$ or Pt FT their F</p> | 5 |
| (iii) | <p>$\frac{1}{2} \times 1200 \times (9^2 - 18^2)$ $= 1200 \times 9.8 \times x \sin 5 - 1500x$</p> <p>Hence $145800 = 475.04846 \dots x$ so $x = 306.91 \dots$ so 307 m (3 s, f.)</p> | M1 B1 M1 A1 A1 A1 | <p>Use of W-E equation with 'x' 2 KE terms present GPE term with resolution GPE term correct All correct cao</p> | 6 |
| (iv) | <p>$P = Fv$ and N2L gives $F - R = 1200a$ Substituting gives $P = (R + 1200a)v$</p> <p>If $a \neq 0$, v is not constant. But P and R are constant so a cannot be constant.</p> | B1 B1 E1 E1 | <p>Shown</p> | 4 |
| | | | | 19 |
| 3 (i) (A) | <p>Let force be P a.c. moments about C $P \times 0.125 - 340 \times 0.5 = 0$</p> <p>$P = 1360$ so 1360 N</p> | M1 A1 A1 | <p>Moments about C. All forces present. No extra forces. Distances correct cao</p> | 3 |
| (i) (B) | <p>Let force be P c.w. moments about E $P \times 2.125 - 340 \times (2 - 0.5) = 0$</p> <p>$P = 240$ so 240 N</p> | M1 A1 A1 | <p>Moments about E. All forces present. No extra forces. Distances correct cao</p> | 3 |

| | | | | |
|-------|--|--|---|----|
| (ii) | $Q \sin \theta \times 2.125 + Q \cos \theta \times 0.9$ $= \frac{25.5Q}{13} + \frac{4.5Q}{13}$ $= \frac{30Q}{13} \text{ so } \frac{30Q}{13} \text{ N m}$ | M1 B1 E1 | Moments expression. Accept $s \leftrightarrow c$. Correct trig ratios or lengths Shown | 3 |
| (iii) | We need $\frac{30Q}{13} = 340 \times 1.5$ so $Q = 221$ Let friction be F and normal reaction R Resolve \rightarrow $221 \cos \theta - F = 0$ so $F = 85$ Resolve \uparrow $221 \sin \theta + R = 340$ so $R = 136$ $F < \mu R$ as not on point of sliding so $85 < 136\mu$ so $\mu > \frac{5}{8}$ | M1 E1 M1 A1 M1 A1 M1 A1 E1 | Moments equn with all relevant forces Shown Accept \leq or = Accept \leq . FT their F and R | 9 |
| | | | | 18 |
| 4 (i) | $4000 \begin{pmatrix} \bar{x} \\ \bar{y} \end{pmatrix} = 4800 \begin{pmatrix} 30 \\ 40 \end{pmatrix} - 800 \begin{pmatrix} 50 \\ 20 \end{pmatrix}$ so $\bar{x} = 26$ $\bar{y} = 44$ | M1 A1 E1 A1 | Any complete method for c.m. Either one RHS term correct or one component of both RHS terms correct [SC 2 for correct \bar{y} seen if M 0] | 4 |
| (ii) | $250 \begin{pmatrix} \bar{x} \\ \bar{y} \end{pmatrix}$ $= 110 \begin{pmatrix} 0 \\ 55 \end{pmatrix} + 40 \begin{pmatrix} 20 \\ 0 \end{pmatrix} + 40 \begin{pmatrix} 40 \\ 20 \end{pmatrix} + 20 \begin{pmatrix} 50 \\ 40 \end{pmatrix} + 40 \begin{pmatrix} 60 \\ 60 \end{pmatrix}$ $\bar{x} = 23.2$ $\bar{y} = 40.2$ | M1 B1 B1 E1 A1 | Any complete method for c.m. Any 2 edges correct mass and c.m. or any 4 edges correct with mass and x or y c.m. coordinate correct. At most one consistent error | 5 |

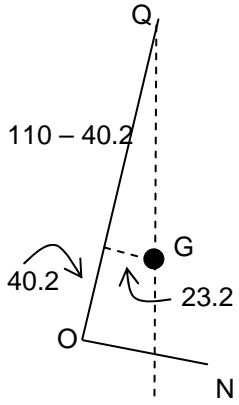
| | | | |
|---|--|---|----|
| <p>(iii)</p>  <p>Angle is $\arctan\left(\frac{23.2}{110-40.2}\right)$</p> <p>= 18.3856.... so 18.4° (3 s. f.)</p> | | <p>B1 Indicating c.m. vertically below Q</p> <p>B1 Clearly identifying correct angle (may be implied) and lengths</p> <p>M1 Award for $\arctan\left(\frac{b}{a}\right)$ where $b = 23.2$ and $a = 69.8$ or 40.2 or where $b = 69.8$ or 40.2 and $a = 23.2$. Allow use of their value for y only.</p> <p>A1 cao</p> | 4 |
| <p>(iv)</p> $10\left(\frac{\bar{x}}{\bar{y}}\right) = 2 \times 1.5 \times \left(\frac{26}{44}\right) + 7\left(\frac{23.2}{40.2}\right)$ <p>$\bar{x} = 24.04$ so 24.0 (3 s.f.)</p> <p>$\bar{y} = 41.34$ so 41.3 (3 s.f.)</p> | | <p>M1 Combining the parts using masses</p> <p>B1 Using both ends</p> <p>A1 All correct</p> <p>A1 cao</p> <p>F1 FT their y values only.</p> | 5 |
| | | | 18 |

4763 Mechanics 3

| | | | | |
|---------------------------|--|--------------------------------------|--|-------------|
| 1(a) (i) | $[\text{Density}] = \text{ML}^{-3}$ $[\text{Kinetic Energy}] = \text{ML}^2 \text{T}^{-2}$ $[\text{Power}] = \text{ML}^2 \text{T}^{-3}$ | B1 B1 B1 | <i>(Deduct B1 for kg m^{-3} etc)</i> | 3 |
| (ii) | $\text{ML}^2 \text{T}^{-3} = [\eta] \text{L} (\text{LT}^{-1})^2$ $[\eta] = \text{ML}^{-1} \text{T}^{-1}$ | B1 M1 A1 | For $[v] = \text{LT}^{-1}$ <i>Can be earned in (iii)</i> Obtaining the dimensions of η | 3 |
| (iii) | $\text{ML}^2 \text{T}^{-3} = (\text{ML}^{-3})^\alpha \text{L}^\beta (\text{LT}^{-1})^\gamma$ $\alpha = 1$ $-3 = -\gamma$ $\gamma = 3$ $2 = -3\alpha + \beta + \gamma$ $\beta = 2$ | B1 cao M1 A1 M1 A1 A1 | Considering powers of T <i>(No ft if $\gamma = 0$)</i> Considering powers of L Correct equation <i>(ft requires 4 terms)</i> <i>(No ft if $\beta = 0$)</i> | 6 |
| (b) | EE at start is $\frac{1}{2}k \times 0.8^2$ EE at end is $\frac{1}{2}k \times 0.3^2$ $\frac{1}{2}k \times 0.8^2 = \frac{1}{2}k \times 0.3^2 + 5.5 \times 9.8 \times 3.5$ Stiffness is 686 N m^{-1} | M1 A1 A1 M1 F1 A1 | Calculating elastic energy k may be $\frac{\lambda}{l}$ or $\frac{\lambda}{1.2}$ Equation involving EE and PE <i>(must have three terms)</i> (A0 for $\lambda = 823.2$) | 6 |
| | | | | [18] |

| | | | | |
|----------------------------------|---|---|---|-------------|
| <p>2 (a)</p> | $\int \pi x y^2 dx = \int_0^a \pi x(a^2 - x^2) dx$ $= \pi \left[\frac{1}{2} a^2 x^2 - \frac{1}{4} x^4 \right]_0^a$ $= \frac{1}{4} \pi a^4$ $\bar{x} = \frac{\frac{1}{4} \pi a^4}{\frac{2}{3} \pi a^3}$ $= \frac{3}{8} a$ | <p>M1</p> <p>A1</p> <p>A1</p> <p>M1</p> <p>E1</p> | <p><i>Limits not required</i></p> <p>For $\frac{1}{2} a^2 x^2 - \frac{1}{4} x^4$</p> | 5 |
| <p>(b) (i)</p> | <p>Area is $\int_1^4 (2 - \sqrt{x}) dx$</p> $= \left[2x - \frac{2}{3} x^{3/2} \right]_1^4 \quad (= \frac{4}{3})$ $\int x y dx = \int_1^4 x(2 - \sqrt{x}) dx$ $= \left[x^2 - \frac{2}{5} x^{5/2} \right]_1^4 \quad (= \frac{13}{5})$ $\bar{x} = \frac{13/5}{4/3} = \frac{39}{20} = 1.95$ $\int \frac{1}{2} y^2 dx = \int_1^4 \frac{1}{2} (2 - \sqrt{x})^2 dx$ $= \left[2x - \frac{4}{3} x^{3/2} + \frac{1}{4} x^2 \right]_1^4 \quad (= \frac{5}{12})$ $\bar{y} = \frac{5/12}{4/3} = \frac{5}{16} = 0.3125$ | <p>M1</p> <p>A1</p> <p>M1</p> <p>A1</p> <p>A1</p> <p>M1</p> <p>A2</p> <p>A1</p> | <p><i>Limits not required</i></p> <p>For $2x - \frac{2}{3} x^{3/2}$</p> <p><i>Limits not required</i></p> <p>For $x^2 - \frac{2}{5} x^{5/2}$</p> <p>$\int (2 - \sqrt{x})^2 dx$ or $\int ((2-y)^2 - 1) y dy$</p> <p>For $2x - \frac{4}{3} x^{3/2} + \frac{1}{4} x^2$ or $\frac{3}{2} y^2 - \frac{4}{3} y^3 + \frac{1}{4} y^4$</p> <p>Give A1 for two terms correct, or all correct with $\frac{1}{2}$ omitted</p> | 9 |
| <p>(ii)</p> | <p>Taking moments about A</p> $T_C \times 3 - W \times 0.95 = 0$ $T_A + T_C = W$ $T_A = \frac{41}{60} W, \quad T_C = \frac{19}{60} W$ | <p>M1</p> <p>A1</p> <p>M1</p> <p>A1</p> | <p>Moments equation (no force omitted)</p> <p>Any correct moments equation (May involve both T_A and T_C)</p> <p>Accept Wg or $W = \frac{4}{3}, \frac{4}{3}g$ here</p> <p>Resolving vertically (or a second moments equation)</p> <p>Accept $0.68W, 0.32W$</p> | 4 |
| | | | | [18] |

| | | | | |
|-------|---|--|---|-------------|
| 3 (i) | By conservation of energy, $\frac{1}{2} \times 0.6 \times 6^2 - \frac{1}{2} \times 0.6 v^2 = 0.6 \times 9.8(1.25 - 1.25 \cos \theta)$ $36 - v^2 = 24.5 - 24.5 \cos \theta$ $v^2 = 11.5 + 24.5 \cos \theta$ | M1 A1 E1 | Equation involving KE and PE | 3 |
| (ii) | $T - 0.6 \times 9.8 \cos \theta = 0.6 \times \frac{v^2}{1.25}$ $T - 5.88 \cos \theta = 0.48(11.5 + 24.5 \cos \theta)$ $T = 5.52 + 17.64 \cos \theta$ | M1 A1 M1 A1 | For acceleration $\frac{v^2}{r}$ Substituting for v^2 | 4 |
| (iii) | String becomes slack when $T = 0$ $\cos \theta = -\frac{5.52}{17.64}$ ($\theta = 108.2^\circ$ or 1.889 rad) $v^2 = 11.5 - 24.5 \times \frac{5.52}{17.64}$ Speed is 1.96 ms^{-1} (3 sf) | M1 A1 M1 A1 cao | <i>May be implied</i> or $0.6 \times 9.8 \times \frac{5.52}{17.64} = 0.6 \times \frac{v^2}{1.25}$ or $-0.6 \times 9.8 \times \frac{v^2 - 11.5}{24.5} = 0.6 \times \frac{v^2}{1.25}$ | 4 |
| (iv) | $T_1 \cos \theta = mg$ $T_1 \times \frac{1.2}{1.25} = 0.6 \times 9.8$ (where θ is angle COP) Tension in OP is 6.125 N $T_1 \sin \theta + T_2 = \frac{mv^2}{0.35}$ $6.125 \times \frac{0.35}{1.25} + T_2 = \frac{0.6 \times 1.4^2}{0.35}$ Tension in CP is 1.645 N | M1 A1 A1 M1 F1B1 A1 | Resolving vertically Horizontal equation (three terms) For LHS and RHS | 7 |
| | | | | [18] |

| | | | |
|--|---|---|--------------------|
| <p>4(i)</p> $T_{AP} = \frac{7.35}{1.5} \times 0.05 \quad (= 0.245)$ $T_{BP} = \frac{7.35}{2.5} \times 0.5 \quad (= 1.47)$ <p>Resultant force up the plane is</p> $T_{BP} - T_{AP} - mg \sin 30^\circ$ $= 1.47 - 0.245 - 0.25 \times 9.8 \sin 30^\circ$ $= 1.47 - 0.245 - 1.225$ $= 0$ <p>Hence there is no acceleration</p> | <p>M1</p> <p>A1</p> <p>A1</p> <p>M1</p> <p>E1</p> | <p>Using Hooke's law</p> <p>or $\frac{7.35}{1.5}(AP - 1.5)$</p> <p>or $\frac{7.35}{2.5}(2.05 - AP)$</p> <p>Correctly shown</p> | <p>5</p> |
| <p>(ii)</p> $T_{AP} = \frac{7.35}{1.5}(0.05 + x) \quad (= 0.245 + 4.9x)$ $T_{BP} = \frac{7.35}{2.5}(4.55 - 1.55 - x - 2.5)$ $= 2.94(0.5 - x)$ $= 1.47 - 2.94x$ | <p>B1</p> <p>M1</p> <p>E1</p> | | <p>3</p> |
| <p>(iii)</p> $T_{BP} - T_{AP} - mg \sin 30^\circ = m \frac{d^2x}{dt^2}$ $(1.47 - 2.94x) - (0.245 + 4.9x) - 1.225 = 0.25 \frac{d^2x}{dt^2}$ $\frac{d^2x}{dt^2} = -31.36x$ <p>Hence the motion is simple harmonic</p> <p>Period is $\frac{2\pi}{\sqrt{31.36}} = \frac{2\pi}{5.6}$</p> <p>Period is 1.12 s (3 sf)</p> | <p>M1</p> <p>A2</p> <p>E1</p> <p>B1 cao</p> | <p>Equation of motion parallel to plane</p> <p>Give A1 for an equation which is correct apart from sign errors</p> <p>Must state conclusion. Working must be fully correct (cao)</p> <p><i>If a is used for accn down plane, then a = 31.36x can earn M1A2; but E1 requires comment about directions</i></p> <p>Accept $\frac{5\pi}{14}$</p> | <p>5</p> |
| <p>(iv)</p> $x = -0.05 \cos 5.6t$ $v = 0.28 \sin 5.6t$ $-0.2 = 0.28 \sin 5.6t$ <p>OR $0.2^2 = 31.36(0.05^2 - x^2)$</p> $x = (\pm) 0.035$ $0.035 = -0.05 \cos 5.6t$ $5.6t = \pi + 0.7956$ <p>Time is 0.703 s (3 sf)</p> | <p>M1</p> <p>A1</p> <p>M1</p> <p>M1</p> <p>A1 cao</p> | <p>For $A \sin \omega t$ or $A \cos \omega t$</p> <p>Allow $\pm 0.05 \sin / \cos 5.6t$</p> <p><i>Implied by $v = \pm 0.28 \sin / \cos 5.6t$</i></p> <p>Using $v = \pm 0.2$ to obtain an equation for t</p> <p>Fully correct strategy for finding the required time</p> | <p>5</p> |
| | | | <p>[18]</p> |

| | | | | |
|---|-------|---|---|------------|
| | (iii) | $P(R G) = \frac{P(R \cap G)}{P(G)} = \frac{0.06}{0.24} = \frac{1}{4} = 0.25$ | M1 for numerator M1 for denominator A1 CAO | [3] |
| | | | TOTAL | [8] |
| 4 | (i) | $P(20 \text{ correct}) = \binom{30}{20} \times 0.6^{20} \times 0.4^{10} = 0.1152$ | M1 $0.6^{20} \times 0.4^{10}$ M1 $\binom{30}{20} \times p^{20} q^{10}$ A1 CAO | [3] |
| | (ii) | Expected number = $100 \times 0.1152 = 11.52$ | M1 A1 FT (Must not round to whole number) | [2] |
| | | | TOTAL | [5] |
| 5 | (i) | $P(\text{Guess correctly}) = 0.1^4 = 0.0001$ | B1 CAO | [1] |
| | (ii) | $P(\text{Guess correctly}) = \frac{1}{4!} = \frac{1}{24}$ | M1 A1 CAO | [2] |
| | | | TOTAL | [3] |
| 6 | (i) | $20 \times 19 \times 18 = 6840$ | M1 A1 | [2] |
| | (ii) | $20^3 - 20 = 7980$ | M1 for figures – 20 A1 | [2] |
| | | | TOTAL | [4] |

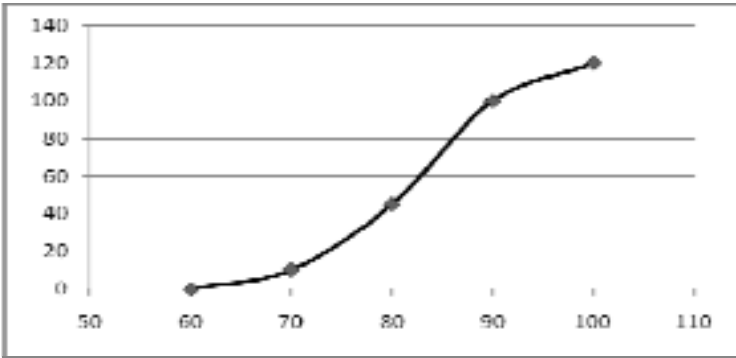
| | | | | | | | | | | | | | | | | |
|----------------------|-------|---|---|------|-----|----|----|-----|----------------------|---|----|----|-----|-----|---|-----|
| 7 | (i) | $10 \times 2 = 20.$ | M1 for 10×2 A1 CAO | [2] | | | | | | | | | | | | |
| | (ii) | $\text{Mean} = \frac{10 \times 65 + 35 \times 75 + 55 \times 85 + 20 \times 95}{120} = \frac{9850}{120} = 82.08$ <p>It is an estimate because the data are grouped.</p> | M1 for midpoints M1 for double pairs A1 CAO E1 indep | [4] | | | | | | | | | | | | |
| | (iii) | $10 \times 65^2 + 35 \times 75^2 + 55 \times 85^2 + 20 \times 95^2 (= 817000)$ $S_{xx} = 817000 - \frac{9850^2}{120} (= 8479.17)$ $s = \sqrt{\frac{8479.17}{119}} = 8.44$ | M1 for Σfx^2 M1 for valid attempt at S_{xx} A1 CAO | [3] | | | | | | | | | | | | |
| | (iv) | $\bar{x} - 2s = 82.08 - 2 \times 8.44 = 65.2$ $\bar{x} + 2s = 82.08 + 2 \times 8.44 = 98.96$ <p>So there are probably some outliers.</p> | M1 FT for $\bar{x} - 2s$ M1 FT for $\bar{x} + 2s$ A1 for both E1 dep on A1 | [4] | | | | | | | | | | | | |
| | (v) | Negative. | E1 | [1] | | | | | | | | | | | | |
| | (vi) | <table style="margin-left: auto; margin-right: auto;"> <tbody> <tr> <td>Upper bound</td> <td>60</td> <td>70</td> <td>80</td> <td>90</td> <td>100</td> </tr> <tr> <td>Cumulative frequency</td> <td>0</td> <td>10</td> <td>45</td> <td>100</td> <td>120</td> </tr> </tbody> </table>  | Upper bound | 60 | 70 | 80 | 90 | 100 | Cumulative frequency | 0 | 10 | 45 | 100 | 120 | C1 for cumulative frequencies S1 for scales L1 for labels 'Length and CF' P1 for points J1 for joining points dep on P1 All dep on attempt at cumulative frequency. | [5] |
| Upper bound | 60 | 70 | 80 | 90 | 100 | | | | | | | | | | | |
| Cumulative frequency | 0 | 10 | 45 | 100 | 120 | | | | | | | | | | | |
| | | | TOTAL | [19] | | | | | | | | | | | | |

| | | | | |
|---|-------|--|--|------|
| 8 | (i) | (A) $P(\text{Low on all 3 days}) = 0.5^3 = 0.125$ or $1/8$ | M1 for 0.5^3 A1 CAO | [2] |
| | | (B) $P(\text{Low on at least 1 day}) = 1 - 0.5^3 = 1 - 0.125 = 0.875$ | M1 for $1 - 0.5^3$ A1 CAO | [2] |
| | | (C) $P(\text{One low, one medium, one high})$ $= 6 \times 0.5 \times 0.35 \times 0.15 = 0.1575$ | M1 for product of probabilities $0.5 \times 0.35 \times 0.15$ or $21/800$ M1 $\times 6$ or $\times 3!$ or 3P_3 A1 CAO | [3] |
| | (ii) | $X \sim B(10, 0.15)$ (A) $P(\text{No days}) = 0.85^{10} = 0.1969$ Or from tables $P(\text{No days}) = 0.1969$ | M1 A1 | [2] |
| | | (B) <i>Either</i> $P(1 \text{ day}) = \binom{10}{1} \times 0.15^1 \times 0.85^9 = 0.3474$ <i>or</i> from tables $P(1 \text{ day}) = P(X \leq 1) - P(X \leq 0)$ $= 0.5443 - 0.1969 = 0.3474$ | M1 $0.15^1 \times 0.85^9$ M1 $\binom{10}{1} \times p^1 q^9$ A1 CAO OR: M2 for $0.5443 - 0.1969$ A1 CAO | [3] |
| | (iii) | Let $X \sim B(20, 0.5)$ <i>Either:</i> $P(X \geq 15) = 1 - 0.9793 = 0.0207 < 5\%$ <i>Or:</i> Critical region is $\{15, 16, 17, 18, 19, 20\}$ 15 lies in the critical region. So there is sufficient evidence to reject H_0 Conclude that there is enough evidence to indicate that the probability of low pollution levels is higher on the new street. H_1 has this form as she believes that the probability of a low pollution level is greater in this street. | <i>Either:</i> B1 for correct probability of 0.0207 M1 for comparison <i>Or:</i> B1 for CR, M1 for comparison A1 CAO dep on B1M1 E1 for conclusion in context E1 indep | [5] |
| | | | TOTAL | [17] |

4767 Statistics 2

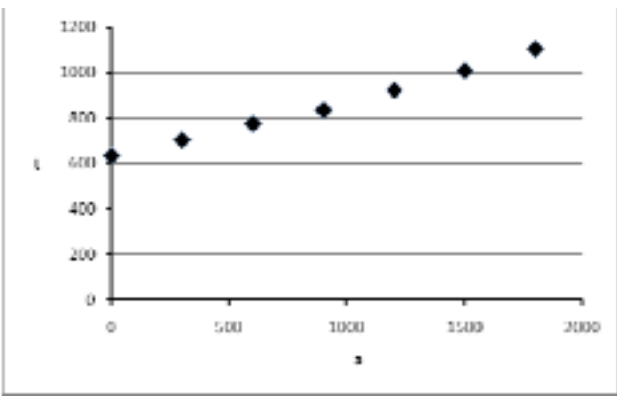
| | | | | |
|--------------|-----|---|--|-------------|
| 1 | (i) |  | <p>G1 For values of a</p> <p>G1 for values of t</p> <p>G1 for axes</p> | [3] |
| (ii) | | <p>a is independent, t is dependent since the values of a are not subject to random variation, but are determined by the runways which the pilot chooses, whereas the values of t are subject to random variation.</p> | <p>B1</p> <p>E1dep</p> <p>E1dep</p> | [3] |
| (iii) | | <p>$\bar{a} = 900$, $\bar{t} = 855.2$</p> $b = \frac{S_{at}}{S_{aa}} = \frac{6037800 - 5987 \times 6300 / 7}{8190000 - 6300^2 / 7} = \frac{649500}{2520000} = 0.258$ <p>OR $b = \frac{6037800 / 7 - 855.29 \times 900}{8190000 / 7 - 900^2} = \frac{92785}{360000} = 0.258$</p> <p>hence least squares regression line is:</p> $t - \bar{t} = b(a - \bar{a})$ $\Rightarrow t - 855.29 = 0.258(a - 900)$ $\Rightarrow t = 0.258a + 623$ | <p>B1 for \bar{a} and \bar{t} used (SOI)</p> <p>M1 for attempt at gradient (b)</p> <p>A1 for 0.258 cao</p> <p>M1 for equation of line</p> <p>A1 FT for complete equation</p> | [5] |
| (iv) | | <p>(A) For $a = 800$, predicted take-off distance = $0.258 \times 800 + 623 = 829$</p> <p>(B) For $a = 2500$, predicted take-off distance = $0.258 \times 2500 + 623 = 1268$</p> <p>Valid relevant comments relating to the predictions such as: First prediction is interpolation so should be reasonable Second prediction is extrapolation and may not be reliable</p> | <p>M1 for at least one prediction attempted</p> <p>A1 for both answers (FT their equation if $b > 0$)</p> <p>E1 (first comment)</p> <p>E1 (second comment)</p> | [4] |
| (v) | | <p>$a = 1200 \Rightarrow$ predicted $t = 0.258 \times 1200 + 623 = 933$</p> <p>Residual = $923 - 933 = -10$</p> <p>The residual is negative because the observed value is less than the predicted value.</p> | <p>M1 for prediction</p> <p>M1 for subtraction</p> <p>A1 FT</p> <p>E1</p> | [4] |
| Total | | | | [19] |

| | | | | |
|-------|-----|---|--|---|
| 2 | (i) | P(1 of 10 is faulty) $= \binom{10}{1} \times 0.02^1 \times 0.98^9 = 0.1667$ | M1 for coefficient M1 for probabilities A1 | [3] |
| | | | | |
| (ii) | | n is large and p is small | B1, B1 Allow appropriate numerical ranges | [2] |
| | | | | |
| (iii) | | $\lambda = 150 \times 0.02 = 3$ (A) $P(X=0) = e^{-3} \frac{3^0}{0!} = 0.0498$ (3 s.f.) or from tables = 0.0498 (B) Expected number = 3 Using tables: $P(X > 3) = 1 - P(X \leq 3)$ = $1 - 0.6472 = 0.3528$ | B1 for mean (soi) M1 for calculation or use of tables A1 B1 expected no = 3 (soi) M1 A1 | [3] [3] |
| | | | | |
| (iv) | | (A) Binomial(2000,0.02) (B) Use Normal approx with $\mu = np = 2000 \times 0.02 = 40$ $\sigma^2 = npq = 2000 \times 0.02 \times 0.98 = 39.2$ $P(X \leq 50) = P\left(Z \leq \frac{50.5 - 40}{\sqrt{39.2}}\right)$ = $P(Z \leq 1.677) = \Phi(1.677) = 0.9532$ NB Poisson approximation also acceptable for full marks | B1 for binomial B1 for parameters B1 B1 B1 for continuity corr. M1 for probability using correct tail A1 CAO | [2] [5] Total [18] |

| | | | | | |
|---|-------|---|---|---|-------------|
| 3 | (i) | (A) | $P(X < 50)$ $= P\left(Z < \frac{50 - 45.3}{11.5}\right)$ $= P(Z < 0.4087)$ $= \Phi(0.4087)$ $= 0.6585$ | M1 for standardising M1 for correct structure of probability calc' | [3] |
| | | (B) | $P(45.3 < X < 50)$ $= 0.6585 - 0.5$ $= 0.1585$ | M1 A1 | [2] |
| | (ii) | <p>From tables $\Phi^{-1}(0.9) = 1.282$</p> $\frac{k - 45.3}{11.5} = 1.282$ $k = 45.3 + 1.282 \times 11.5 = 60.0$ | B1 for 1.282 seen M1 for equation in k A1 CAO | [3] | |
| | (iii) | $P(\text{score} = 111)$ $= P(110.5 < Y < 111.5)$ $= P\left(\frac{110.5 - 100}{15} < Z < \frac{111.5 - 100}{15}\right)$ $= P(0.7 < Z < 0.7667)$ $= \Phi(0.7667) - \Phi(0.7)$ $= 0.7784 - 0.7580$ $= 0.0204$ | B1 for both continuity corrections M1 for standardising M1 for correct structure of probability calc' | A1 CAO [4] | |
| | (iv) | <p>From tables, $\Phi^{-1}(0.3) = -0.5244$, $\Phi^{-1}(0.8) = 0.8416$</p> $22 = \mu + 0.8416 \sigma$ $15 = \mu - 0.5244 \sigma$ $7 = 1.3660 \sigma$ $\sigma = 5.124, \mu = 17.69$ | B1 for 0.5244 or 0.8416 seen M1 for at least one equation in z , μ & σ A1 for both correct M1 for attempt to solve two appropriate equations A1 CAO for both | [5] | |
| | | | | TOTAL | [17] |

| | | | | |
|---|-------|--|--|------------------------|
| 4 | (i) | <p>H_0: no association between size of business and recycling service used. H_1: some association between size of business and recycling service used.</p> | B1 for both | [1] |
| | | | | |
| | (ii) | <p>Expected frequency = $78/285 \times 180 = 49.2632$ Contribution = $(52 - 49.2632)^2 / 49.2632$ = 0.1520</p> | <p>M1 A1 M1 for valid attempt at $(O-E)^2/E$ A1 NB Answer given Allow 0.152</p> | [4] |
| | | | | |
| | (iii) | <p>Test statistic $X^2 = 0.6041$</p> <p>Refer to χ_2^2 Critical value at 5% level = 5.991 Result is not significant</p> <p>There is no evidence to suggest any association between size of business and recycling service used. NB if H_0 H_1 reversed, or ‘correlation’ mentioned in part (i), do not award B1 in part (i) or E1 in part (iii).</p> | <p>B1</p> <p>B1 for 2 deg of f(seen) B1 CAO for cv B1 for not significant</p> <p>E1</p> | [5] |
| | | | | |
| | (iv) | <p>$H_0: \mu = 32.8$; $H_1: \mu < 32.8$ Where μ denotes the population mean weight of rubbish in the bins.</p> $\text{Test statistic} = \frac{30.9 - 32.8}{3.4/\sqrt{50}} = -\frac{1.9}{0.4808} = -3.951$ <p>5% level 1 tailed critical value of $z = -1.645$</p> <p>$-3.951 < -1.645$ so significant. There is sufficient evidence to reject H_0</p> <p>There is evidence to suggest that the weight of rubbish in dustbins has been reduced.</p> | <p>B1 for use of 32.8 B1 for both correct B1 for definition of μ</p> <p>M1 must include $\sqrt{50}$ A1</p> <p>B1 for ± 1.645</p> <p>M1 for sensible comparison leading to a conclusion</p> <p>A1 for conclusion in words in context</p> <p style="text-align: right;">TOTAL</p> | <p>[8]</p> <p>[18]</p> |

4768 Statistics 3

| 1 (i) | <p>H_0: The number of eggs hatched can be modelled by $B(3, \frac{1}{2})$ H_1: The number of eggs hatched cannot be modelled by $B(3, \frac{1}{2})$</p> <p>With $p = \frac{1}{2}$</p> <table border="1" data-bbox="240 465 1077 577"> <thead> <tr> <th>Probability</th> <th>0.125</th> <th>0.375</th> <th>0.375</th> <th>0.125</th> </tr> </thead> <tbody> <tr> <td>Exp'd frequency</td> <td>10</td> <td>30</td> <td>30</td> <td>10</td> </tr> <tr> <td>Obs'd frequency</td> <td>7</td> <td>23</td> <td>29</td> <td>21</td> </tr> </tbody> </table> <p>$\chi^2 = 0.9 + 1.6333 + 0.0333 + 12.1$ $= 14.666(7)$</p> <p>Refer to χ_3^2.</p> <p>Upper 5% point is 7.815. Significant. Suggests it is reasonable to suppose model with $p = \frac{1}{2}$ does not apply.</p> | Probability | 0.125 | 0.375 | 0.375 | 0.125 | Exp'd frequency | 10 | 30 | 30 | 10 | Obs'd frequency | 7 | 23 | 29 | 21 | <p>B1 B1</p> | <p>M1 Probs \times 80 for expected frequencies. A1 All correct. M1 Calculation of χ^2. A1 c.a.o.</p> <p>M1 Allow correct df (= cells – 1) from wrongly grouped table and ft. Otherwise, no ft if wrong. $P(\chi^2 > 14.667) = 0.00212$.</p> <p>A1 No ft from here if wrong. A1 ft only c's test statistic. A1 ft only c's test statistic.</p> | <p>[10]</p> |
|-----------------|--|---|--|-------------|-------|-------|-----------------|----|----|----|----|-----------------|---|----|----|----|-----------------------------|---|-------------|
| Probability | 0.125 | 0.375 | 0.375 | 0.125 | | | | | | | | | | | | | | | |
| Exp'd frequency | 10 | 30 | 30 | 10 | | | | | | | | | | | | | | | |
| Obs'd frequency | 7 | 23 | 29 | 21 | | | | | | | | | | | | | | | |
| (ii) | <p>$\bar{x} = \frac{144}{80} = 1.8$ $\therefore \hat{p} = \frac{1.8}{3} = 0.6$</p> | <p>B1 B1</p> | <p>C.a.o.</p> <p>Use of $E(X) = np$. ft c's mean, provided $0 < \hat{p} < 1$.</p> | <p>[2]</p> | | | | | | | | | | | | | | | |
| (iii) | <p>Refer to χ_2^2.</p> <p>Upper 5% point is 5.991.</p> <p>Suggests it is reasonable to suppose model with estimated p does apply.</p> | <p>M1 A1 A1</p> | <p>Allow df 1 less than in part (i). No ft if wrong.</p> <p>No ft if wrong.</p> <p>ft provided previous A mark awarded.</p> | <p>[3]</p> | | | | | | | | | | | | | | | |
| (iv) | <p>For example: Estimating p leads to an improved fit at the expense of the loss of 1 degree of freedom. The model in (i) fails due to a large underestimate for $X = 3$.</p> | <p>E2</p> | <p>Reward any two sensible points for E1 each.</p> | <p>[2]</p> | | | | | | | | | | | | | | | |
| Total | | | | [17] | | | | | | | | | | | | | | | |

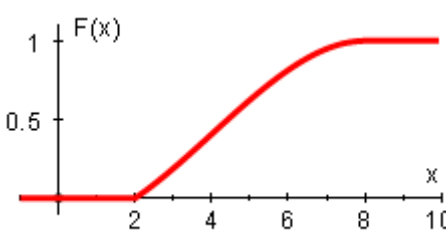
| | | | |
|---------------------------------------|---|--|------------|
| <p>2 (a)</p> <p>(i)</p> | $f(x) = \frac{1}{72}(8x - x^2), \quad 2 \leq x \leq 8$ $F(x) = \int_2^x \frac{1}{72}(8t - t^2) dt$ $= \frac{1}{72} \left[4t^2 - \frac{t^3}{3} \right]_2^x$ $= \frac{1}{72} \left(4x^2 - \frac{x^3}{3} - 16 + \frac{8}{3} \right) = \frac{12x^2 - x^3 - 40}{216}$ | <p>M1 Correct integral with limits (which may be implied subsequently).</p> <p>A1 Correctly integrated</p> <p>A1 Limits used. Accept unsimplified form.</p> | <p>[3]</p> |
| <p>(ii)</p> |  | <p>G1 Correct shape; nothing below $y = 0$; non-negative gradient.</p> <p>G1 Labels at $(2, 0)$ and $(8, 1)$.</p> <p>G1 Curve (horizontal lines) shown for $x < 2$ and $x > 8$.</p> | <p>[3]</p> |
| <p>(iii)</p> | $F(m) = \frac{1}{2} \quad \therefore \frac{12m^2 - m^3 - 40}{216} = \frac{1}{2}$ $\therefore 12m^2 - m^3 - 40 = 108$ $\therefore m^3 - 12m^2 + 148 = 0$ <p>Either</p> $F(4.42) = 0.5003(977) \approx 0.5$ <p>Or</p> $4.42^3 - 12 \times 4.42^2 + 148 = -0.0859(12) \approx 0$ $\therefore m \approx 4.42$ | <p>M1 Use of definition of median. Allow use of c's $F(x)$.</p> <p>A1 Convincingly rearranged. Beware: answer given.</p> <p>E1 Convincingly shown, e.g. 4.418 or better seen.</p> | <p>[3]</p> |

| <p>2 (b) $H_0: m = 4.42$ $H_1: m \neq 4.42$ where m is the population median</p> <table border="1" style="margin: 10px auto; border-collapse: collapse; text-align: center;"> <thead> <tr> <th style="padding: 5px;">Weights</th> <th style="padding: 5px;">- 4.42</th> <th style="padding: 5px;">Rank of diff </th> </tr> </thead> <tbody> <tr><td style="padding: 5px;">3.16</td><td style="padding: 5px;">-1.26</td><td style="padding: 5px;">7</td></tr> <tr><td style="padding: 5px;">3.62</td><td style="padding: 5px;">-0.80</td><td style="padding: 5px;">6</td></tr> <tr><td style="padding: 5px;">3.80</td><td style="padding: 5px;">-0.62</td><td style="padding: 5px;">4</td></tr> <tr><td style="padding: 5px;">3.90</td><td style="padding: 5px;">-0.52</td><td style="padding: 5px;">3</td></tr> <tr><td style="padding: 5px;">4.02</td><td style="padding: 5px;">-0.40</td><td style="padding: 5px;">2</td></tr> <tr><td style="padding: 5px;">4.72</td><td style="padding: 5px;">0.30</td><td style="padding: 5px;">1</td></tr> <tr><td style="padding: 5px;">5.14</td><td style="padding: 5px;">0.72</td><td style="padding: 5px;">5</td></tr> <tr><td style="padding: 5px;">6.36</td><td style="padding: 5px;">1.94</td><td style="padding: 5px;">8</td></tr> <tr><td style="padding: 5px;">6.50</td><td style="padding: 5px;">2.08</td><td style="padding: 5px;">9</td></tr> <tr><td style="padding: 5px;">6.58</td><td style="padding: 5px;">2.16</td><td style="padding: 5px;">10</td></tr> <tr><td style="padding: 5px;">6.68</td><td style="padding: 5px;">2.26</td><td style="padding: 5px;">11</td></tr> <tr><td style="padding: 5px;">6.78</td><td style="padding: 5px;">2.36</td><td style="padding: 5px;">12</td></tr> </tbody> </table> <p style="margin-top: 10px;">$W_- = 2 + 3 + 4 + 6 + 7 = 22$</p> <p>Refer to Wilcoxon single sample tables for $n = 12$. Lower 2½% point is 13 (or upper is 65 if 56 used). Result is not significant. Evidence suggests that a median of 4.42 is consistent with these data.</p> | Weights | - 4.42 | Rank of diff | 3.16 | -1.26 | 7 | 3.62 | -0.80 | 6 | 3.80 | -0.62 | 4 | 3.90 | -0.52 | 3 | 4.02 | -0.40 | 2 | 4.72 | 0.30 | 1 | 5.14 | 0.72 | 5 | 6.36 | 1.94 | 8 | 6.50 | 2.08 | 9 | 6.58 | 2.16 | 10 | 6.68 | 2.26 | 11 | 6.78 | 2.36 | 12 | <p>B1 Both. Accept hypotheses in words. B1 Adequate definition of m to include “population”.</p> <p>M1 for subtracting 4.42.</p> <p>M1 for ranks. A1 ft if ranks wrong.</p> <p>B1 ($W_+ = 1 + 5 + 8 + 9 + 10 + 11 + 12 = 56$) M1 No ft from here if wrong. A1 i.e. a 2-tail test. No ft from here if wrong. A1 ft only c’s test statistic. A1 ft only c’s test statistic.</p> | <p>[10]</p> <p>Total [19]</p> |
|--|---------|--------|------------------|------|-------|---|------|-------|---|------|-------|---|------|-------|---|------|-------|---|------|------|---|------|------|---|------|------|---|------|------|---|------|------|----|------|------|----|------|------|----|---|---|
| | Weights | - 4.42 | Rank of diff | | | | | | | | | | | | | | | | | | | | | | | | | | | | | | | | | | | | | | |
| | 3.16 | -1.26 | 7 | | | | | | | | | | | | | | | | | | | | | | | | | | | | | | | | | | | | | | |
| | 3.62 | -0.80 | 6 | | | | | | | | | | | | | | | | | | | | | | | | | | | | | | | | | | | | | | |
| | 3.80 | -0.62 | 4 | | | | | | | | | | | | | | | | | | | | | | | | | | | | | | | | | | | | | | |
| | 3.90 | -0.52 | 3 | | | | | | | | | | | | | | | | | | | | | | | | | | | | | | | | | | | | | | |
| | 4.02 | -0.40 | 2 | | | | | | | | | | | | | | | | | | | | | | | | | | | | | | | | | | | | | | |
| | 4.72 | 0.30 | 1 | | | | | | | | | | | | | | | | | | | | | | | | | | | | | | | | | | | | | | |
| | 5.14 | 0.72 | 5 | | | | | | | | | | | | | | | | | | | | | | | | | | | | | | | | | | | | | | |
| | 6.36 | 1.94 | 8 | | | | | | | | | | | | | | | | | | | | | | | | | | | | | | | | | | | | | | |
| | 6.50 | 2.08 | 9 | | | | | | | | | | | | | | | | | | | | | | | | | | | | | | | | | | | | | | |
| | 6.58 | 2.16 | 10 | | | | | | | | | | | | | | | | | | | | | | | | | | | | | | | | | | | | | | |
| | 6.68 | 2.26 | 11 | | | | | | | | | | | | | | | | | | | | | | | | | | | | | | | | | | | | | | |
| | 6.78 | 2.36 | 12 | | | | | | | | | | | | | | | | | | | | | | | | | | | | | | | | | | | | | | |

| | | | | |
|---------------------|---|---|--|--|
| <p>3 (i)</p> | <p>Must assume</p> <ul style="list-style-type: none"> • Normality of population ... • ... of <u>differences</u>. <p>$H_0: \mu_D = 0$ $H_1: \mu_D > 0$</p> <p>Where μ_D is the (population) mean reduction/difference in cholesterol level.</p> <p><u>MUST</u> be PAIRED COMPARISON t test. Differences (reductions) (before – after) are:</p> <p>–0.1 1.7 –1.2 1.1 1.4 0.5 0.9 2.2 –0.1 2.0 0.7 0.3</p> <p>$\bar{x} = 0.7833$ $s_{n-1} = 0.9833(46)$ ($s_{n-1}^2 = 0.966969$)</p> <p>Test statistic is $\frac{0.7833 - 0}{\frac{0.9833}{\sqrt{12}}}$</p> <p style="text-align: right;">= 2.7595.</p> <p>Refer to t_{11}.</p> <p>Single-tailed 1% point is 2.718. Significant. Seems mean cholesterol level has fallen.</p> | <p>B1 B1 B1 B1 B1 M1 M1 A1 M1 A1 A1 A1</p> | <p>Both. Accept alternatives e.g. $\mu_D < 0$ for H_1, or $\mu_B - \mu_A$ etc provided adequately defined. Hypotheses in words only must include “population”. Do NOT allow “$\bar{X} = \dots$” or similar unless \bar{X} is clearly and explicitly stated to be a <u>population</u> mean.</p> <p>For adequate verbal definition. Allow absence of “population” if correct notation μ is used.</p> <p>Allow “after – before” if consistent with alternatives above.</p> <p>Do not allow $s_n = 0.9415$ ($s_n^2 = 0.8864$)</p> <p>Allow c's \bar{x} and/or s_{n-1}. Allow alternative: $0 + (c's\ 2.718) \times \frac{0.9833}{\sqrt{12}}$ (= 0.7715) for subsequent comparison with \bar{x}. (Or $\bar{x} - (c's\ 2.718) \times \frac{0.9833}{\sqrt{12}}$ (= 0.0118) for comparison with 0.)</p> <p>c.a.o. but ft from here in any case if wrong. Use of $0 - \bar{x}$ scores M1A0, but ft.</p> <p>No ft from here if wrong. $P(t > 2.7595) = 0.009286$.</p> <p>No ft from here if wrong. ft only c's test statistic. ft only c's test statistic.</p> | <p>[11]</p> |
| <p>(ii)</p> | <p>CI is $\bar{x} \pm 2.201 \times \frac{s}{\sqrt{12}} = (-0.5380, 1.4046)$</p> <p>$\bar{x} = \frac{1}{2}(1.4046 - 0.5380) = 0.4333$</p> <p>$s = (1.4046 - 0.4333) \times \frac{\sqrt{12}}{2.201} = 1.5287$</p> <p>Using this interval the doctor might conclude that the mean cholesterol level did not seem to have been reduced.</p> | <p>M1 B1 A1 B1 M1 A1 E1</p> | <p>Overall structure, seen or implied. From t_{11}, seen or implied.</p> <p>Fully correct pair of equations using the given interval, seen or implied.</p> <p>Substitute \bar{x} and rearrange to find s. c.a.o.</p> <p>Accept any sensible comment or interpretation of <u>this</u> interval.</p> | <p>[7]</p> <p style="text-align: right;">Total [18]</p> |

| | | | | |
|---|--|---------------------------------------|---|-------------|
| <p>4</p> <p>$A \sim N(80, \sigma = 11)$ $B \sim N(70, \sigma = v)$</p> <p>(i)</p> $P(A < 90) = P\left(Z < \frac{90 - 80}{11} = 0.9091\right)$ $= 0.8182$ | | | <p>When a candidate's answers suggest that (s)he appears to have neglected to use the difference columns of the Normal distribution tables penalise the first occurrence only.</p> <p>For standardising. Award once, here or elsewhere.</p> <p>c.a.o.</p> | <p>[3]</p> |
| <p>(ii)</p> $W_B = B_1 + B_2 + \dots + B_6 + 15 \sim N(435, \sigma^2 = v^2 + v^2 + \dots + v^2 = 6v^2)$ $P(\text{this} < 450) = P\left(Z < \frac{450 - 435}{v\sqrt{6}}\right) = 0.8463$ $\therefore \frac{450 - 435}{v\sqrt{6}} = \Phi^{-1}(0.8463) = 1.021$ $\therefore v = \frac{15}{1.021 \times \sqrt{6}} = 5.9977 = 6 \text{ grams (nearest gram)}$ | | <p>B1 B1 M1 B1 A1</p> | <p>Mean. Expression for variance. Formulation of the problem. Inverse Normal. Convincingly shown, beware A.G.</p> | <p>[5]</p> |
| <p>(iii)</p> $W_A = A_1 + A_2 + \dots + A_5 + 25 \sim N(425, \sigma^2 = 11^2 + 11^2 + \dots + 11^2 = 605)$ $D = W_A - W_B \sim N(-10, 605 + 216 = 821)$ <p>Want $P(W_A > W_B) = P(W_A - W_B > 0)$</p> $= P\left(Z > \frac{0 - (-10)}{\sqrt{821}} = 0.3490\right) = 1 - 0.6365 = 0.3635$ | | <p>B1 M1 A1 M1 A1</p> | <p>Mean. Accept "B - A". Variance. Accept sd (= 28.65). c.a.o.</p> | <p>[5]</p> |
| <p>(iv)</p> $\bar{x} = \frac{3126.0}{60} = 52.1,$ $s = \sqrt{\frac{164223.96 - 60 \times 52.1^2}{59}} = 4.8$ <p>CI is given by</p> $52.1 \pm 1.96 \times \frac{4.8}{\sqrt{60}}$ $= 52.1 \pm 1.2146 = (50.885(4), 53.314(6))$ | | <p>B1 M1 B1 M1 A1</p> | <p>Both correct. c.a.o. Must be expressed as an interval.</p> | <p>[5]</p> |
| Total | | | | [18] |

4771 Decision Mathematics 1

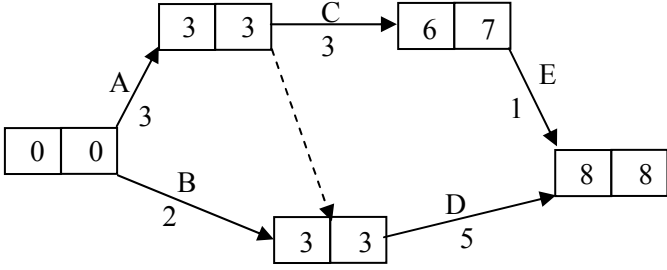
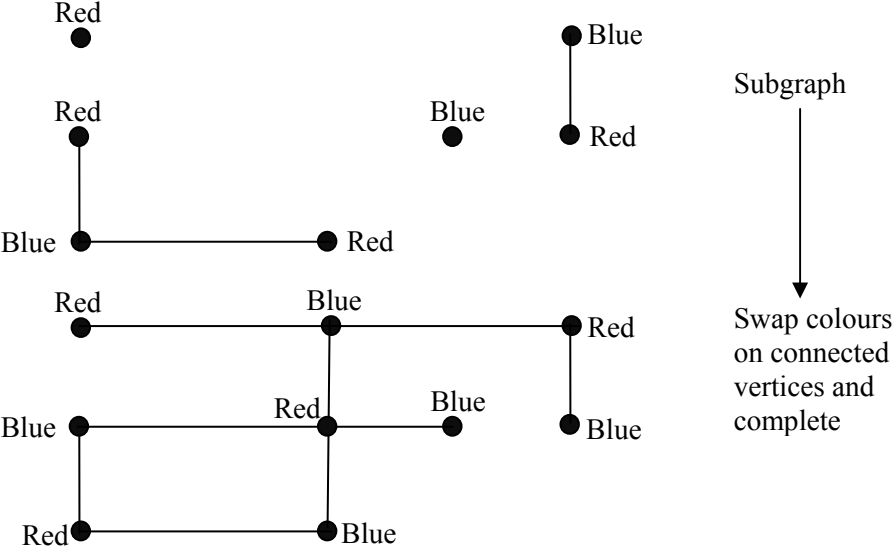
| | | | |
|-------------|-------------------------------|--|--|
| <p>1</p> | <p>(i) & (ii)</p> |  <p>Critical activities: A and D</p> | <p>M1 activity-on-arc A1 C and E OK A1 D OK M1 forward pass A1 M1 backward pass A1 B1</p> |
| <p>2</p> | <p>(i)</p> |  <p>Subgraph</p> <p>Swap colours on connected vertices and complete</p> | <p>M1 subgraph A1 M1 Changing colours A1 top right A1 bottom left A1 not singletons B1</p> |
| <p>(ii)</p> | | <p>The rule does not specify a well-defined and terminating set of actions.</p> | <p>B1</p> |

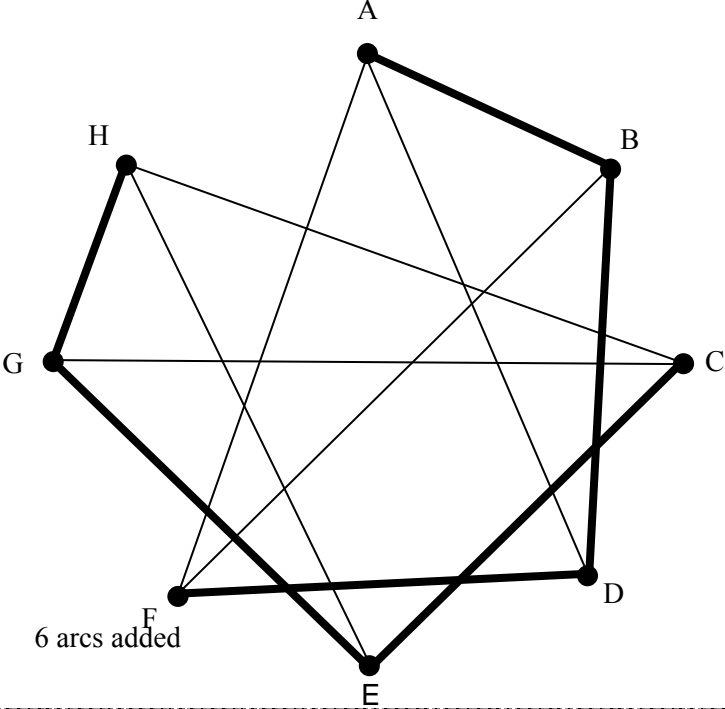
| | | | |
|---|-------|---|--------------------|
| 3 | (i) | No repeated arcs. No loops | B1 B1 |
| | (ii) | Two disconnected sets, {A,B,D,F} and {C,E,G,H} | M1 A1 |
| | (iii) |  | M1 A1 B1 |
| | (iv) | $4 \times 4 = 16$ or $\binom{8}{2} - 12 = 28 - 12 = 16$ | B1 |

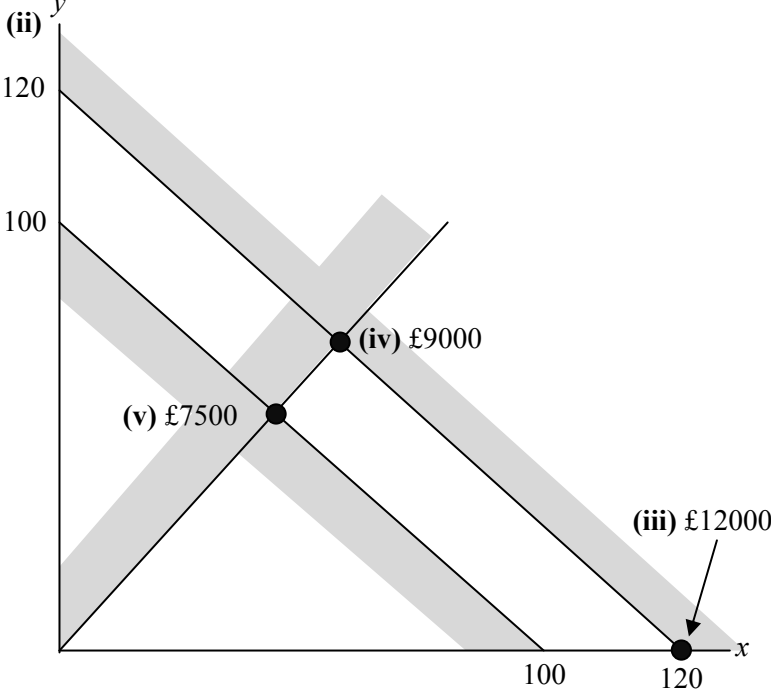
| | | | |
|-------------|------------|--|---|
| <p>4</p> | <p>(i)</p> | <p>e.g. Let x be the number of adult seats sold. Let y be the number of child seats sold. $x + y \leq 120$ $x + y \geq 100$ $x \geq y$</p> | <p>M1 A1 B1 B1 B1</p> |
| | | <p>(ii)</p>  | <p>B3 lines (scale must be clear) B1 shading (axes must be clear)</p> <p>B1 point + amount</p> <p>M1 point A1 amount</p> <p>M1 point A1 amount</p> |
| <p>(vi)</p> | | <p>$6000 + 60c > 10000 \Rightarrow c \geq 67$</p> | <p>M1 A1</p> |

| | | | |
|----------|-------------------------------|---|---|
| <p>5</p> | <p>(i) & (ii)</p> | <p>shortest route: A E C F distance: 26 miles</p> | <p>M1 network A1 arcs A1 lengths M1 Dijkstra A1 working values B1 order of labelling labels B1 B1</p> |
| | <p>(iii)</p> | <p>CE CD AE CF AD BF AB EF</p> <p>total length of connector = 45</p> | <p>M1 5 arc connector A1 AD not included A1 all OK, inc order B1 B1</p> |
| | <p>(iv)</p> | <p>A 3 miles (or length = 9) B 2 miles (or length = 10)</p> | <p>B1 B1</p> |

| | | | | | | | | | | | | | | | | | | | | | | | | | | | | | | | | | | | | | | | | | | | | | | | | | | | |
|-------|-------|---|--|-----|-------|--|---|---|--------|--|---|---|-----|--|---|---|----|--|-------|-----|-------|--|---|---|-----|--|-------|-----|-------|--|-----------------------------------|-----|-------|--|-------|-----|--------|--|---|---|-----|-------------------------------|---|-----|-------|--|---|--|--------|-------------------------|---|
| 6 | (i) | e.g. 0, 1, 2 → fall 3, 4, 5, 6, 7, 8 → not fall 9 → redraw | M1 ignore at least 1 A1 proportions A1 correct A1 efficient | | | | | | | | | | | | | | | | | | | | | | | | | | | | | | | | | | | | | | | | | | | | | | | | |
| | | | | | | | | | | | | | | | | | | | | | | | | | | | | | | | | | | | | | | | | | | | | | | | | | | | |
| | (ii) | <table border="0"> <tr> <td>apple</td> <td>r n</td> <td>fall?</td> <td></td> </tr> <tr> <td>1</td> <td>1</td> <td>yes</td> <td></td> </tr> <tr> <td>2</td> <td>3</td> <td>no</td> <td></td> </tr> <tr> <td>3</td> <td>8</td> <td>no</td> <td></td> </tr> <tr> <td>4</td> <td>0</td> <td>yes</td> <td></td> </tr> <tr> <td>5</td> <td>2</td> <td>yes</td> <td></td> </tr> <tr> <td>6</td> <td>7</td> <td>no</td> <td></td> </tr> </table> Three apples fall in this simulation. | apple | r n | fall? | | 1 | 1 | yes | | 2 | 3 | no | | 3 | 8 | no | | 4 | 0 | yes | | 5 | 2 | yes | | 6 | 7 | no | | M1 A2 -1 each error B1√ | | | | | | | | | | | | | | | | | | | | |
| apple | r n | fall? | | | | | | | | | | | | | | | | | | | | | | | | | | | | | | | | | | | | | | | | | | | | | | | | | |
| 1 | 1 | yes | | | | | | | | | | | | | | | | | | | | | | | | | | | | | | | | | | | | | | | | | | | | | | | | | |
| 2 | 3 | no | | | | | | | | | | | | | | | | | | | | | | | | | | | | | | | | | | | | | | | | | | | | | | | | | |
| 3 | 8 | no | | | | | | | | | | | | | | | | | | | | | | | | | | | | | | | | | | | | | | | | | | | | | | | | | |
| 4 | 0 | yes | | | | | | | | | | | | | | | | | | | | | | | | | | | | | | | | | | | | | | | | | | | | | | | | | |
| 5 | 2 | yes | | | | | | | | | | | | | | | | | | | | | | | | | | | | | | | | | | | | | | | | | | | | | | | | | |
| 6 | 7 | no | | | | | | | | | | | | | | | | | | | | | | | | | | | | | | | | | | | | | | | | | | | | | | | | | |
| | | | | | | | | | | | | | | | | | | | | | | | | | | | | | | | | | | | | | | | | | | | | | | | | | | | |
| | (iii) | <table border="0"> <tr> <td>apple</td> <td>r n</td> <td>fall?</td> <td></td> </tr> <tr> <td>2</td> <td>0</td> <td>yes</td> <td></td> </tr> <tr> <td>3</td> <td>1</td> <td>yes</td> <td></td> </tr> <tr> <td>6</td> <td>4</td> <td>no</td> <td></td> </tr> </table> <table border="0"> <tr> <td>apple</td> <td>r n</td> <td>fall?</td> <td></td> </tr> <tr> <td>6</td> <td>4</td> <td>no</td> <td></td> </tr> </table> <table border="0"> <tr> <td>apple</td> <td>r n</td> <td>fall?</td> <td></td> </tr> <tr> <td>6</td> <td>8</td> <td>no</td> <td></td> </tr> </table> <table border="0"> <tr> <td>apple</td> <td>r n</td> <td>fall?</td> <td></td> </tr> <tr> <td>6</td> <td>0</td> <td>yes</td> <td>5 days before all have fallen</td> </tr> </table> | apple | r n | fall? | | 2 | 0 | yes | | 3 | 1 | yes | | 6 | 4 | no | | apple | r n | fall? | | 6 | 4 | no | | apple | r n | fall? | | 6 | 8 | no | | apple | r n | fall? | | 6 | 0 | yes | 5 days before all have fallen | M1 A2 -1 each error A1√ | | | | | | | | |
| apple | r n | fall? | | | | | | | | | | | | | | | | | | | | | | | | | | | | | | | | | | | | | | | | | | | | | | | | | |
| 2 | 0 | yes | | | | | | | | | | | | | | | | | | | | | | | | | | | | | | | | | | | | | | | | | | | | | | | | | |
| 3 | 1 | yes | | | | | | | | | | | | | | | | | | | | | | | | | | | | | | | | | | | | | | | | | | | | | | | | | |
| 6 | 4 | no | | | | | | | | | | | | | | | | | | | | | | | | | | | | | | | | | | | | | | | | | | | | | | | | | |
| apple | r n | fall? | | | | | | | | | | | | | | | | | | | | | | | | | | | | | | | | | | | | | | | | | | | | | | | | | |
| 6 | 4 | no | | | | | | | | | | | | | | | | | | | | | | | | | | | | | | | | | | | | | | | | | | | | | | | | | |
| apple | r n | fall? | | | | | | | | | | | | | | | | | | | | | | | | | | | | | | | | | | | | | | | | | | | | | | | | | |
| 6 | 8 | no | | | | | | | | | | | | | | | | | | | | | | | | | | | | | | | | | | | | | | | | | | | | | | | | | |
| apple | r n | fall? | | | | | | | | | | | | | | | | | | | | | | | | | | | | | | | | | | | | | | | | | | | | | | | | | |
| 6 | 0 | yes | 5 days before all have fallen | | | | | | | | | | | | | | | | | | | | | | | | | | | | | | | | | | | | | | | | | | | | | | | | |
| | | | | | | | | | | | | | | | | | | | | | | | | | | | | | | | | | | | | | | | | | | | | | | | | | | | |
| | (iv) | <table border="0"> <tr> <td>apple</td> <td>r n</td> <td>fall?</td> <td></td> </tr> <tr> <td>1</td> <td></td> <td>picked</td> <td></td> </tr> <tr> <td>2</td> <td>1</td> <td>yes</td> <td></td> </tr> <tr> <td>3</td> <td>3</td> <td>no</td> <td></td> </tr> <tr> <td>4</td> <td>8</td> <td>no</td> <td></td> </tr> <tr> <td>5</td> <td>0</td> <td>yes</td> <td></td> </tr> <tr> <td>6</td> <td>2</td> <td>yes</td> <td></td> </tr> </table> <table border="0"> <tr> <td>apple</td> <td>r n</td> <td>fall?</td> <td></td> </tr> <tr> <td>3</td> <td></td> <td>picked</td> <td></td> </tr> <tr> <td>4</td> <td>7</td> <td>no</td> <td></td> </tr> </table> <table border="0"> <tr> <td>apple</td> <td>r n</td> <td>fall?</td> <td></td> </tr> <tr> <td>4</td> <td></td> <td>picked</td> <td>3 days before none left</td> </tr> </table> | apple | r n | fall? | | 1 | | picked | | 2 | 1 | yes | | 3 | 3 | no | | 4 | 8 | no | | 5 | 0 | yes | | 6 | 2 | yes | | apple | r n | fall? | | 3 | | picked | | 4 | 7 | no | | apple | r n | fall? | | 4 | | picked | 3 days before none left | M1 A2 -1 each error B1√ |
| apple | r n | fall? | | | | | | | | | | | | | | | | | | | | | | | | | | | | | | | | | | | | | | | | | | | | | | | | | |
| 1 | | picked | | | | | | | | | | | | | | | | | | | | | | | | | | | | | | | | | | | | | | | | | | | | | | | | | |
| 2 | 1 | yes | | | | | | | | | | | | | | | | | | | | | | | | | | | | | | | | | | | | | | | | | | | | | | | | | |
| 3 | 3 | no | | | | | | | | | | | | | | | | | | | | | | | | | | | | | | | | | | | | | | | | | | | | | | | | | |
| 4 | 8 | no | | | | | | | | | | | | | | | | | | | | | | | | | | | | | | | | | | | | | | | | | | | | | | | | | |
| 5 | 0 | yes | | | | | | | | | | | | | | | | | | | | | | | | | | | | | | | | | | | | | | | | | | | | | | | | | |
| 6 | 2 | yes | | | | | | | | | | | | | | | | | | | | | | | | | | | | | | | | | | | | | | | | | | | | | | | | | |
| apple | r n | fall? | | | | | | | | | | | | | | | | | | | | | | | | | | | | | | | | | | | | | | | | | | | | | | | | | |
| 3 | | picked | | | | | | | | | | | | | | | | | | | | | | | | | | | | | | | | | | | | | | | | | | | | | | | | | |
| 4 | 7 | no | | | | | | | | | | | | | | | | | | | | | | | | | | | | | | | | | | | | | | | | | | | | | | | | | |
| apple | r n | fall? | | | | | | | | | | | | | | | | | | | | | | | | | | | | | | | | | | | | | | | | | | | | | | | | | |
| 4 | | picked | 3 days before none left | | | | | | | | | | | | | | | | | | | | | | | | | | | | | | | | | | | | | | | | | | | | | | | | |
| | | | | | | | | | | | | | | | | | | | | | | | | | | | | | | | | | | | | | | | | | | | | | | | | | | | |
| | (v) | more simulations | B1 | | | | | | | | | | | | | | | | | | | | | | | | | | | | | | | | | | | | | | | | | | | | | | | | |

4776 Numerical Methods

| | | | | | | | | | |
|----------|--------|----------|----------|----------|-------------------------|---------|----------------------|---------------------------------|-----------|
| 1 | x | LHS | | | | | | | |
| | 1.3 | 2.868415 | < 3 | | | | | | |
| | 1.5 | 3.181981 | > 3 | | | | | | [M1A1] |
| | | | | mpe | <i>(may be implied)</i> | | | | |
| | 1.4 | 3.017945 | | 0.1 | | | | | [M1] |
| | 1.35 | 2.941413 | | 0.05 | | | | | [A1] |
| | 1.375 | 2.979232 | | 0.025 | | | | | [A1] |
| | 1.3875 | | | 0.0125 | | | | <i>finishing at this point:</i> | [A1] |
| | mpe: | 0.00625 | 0.003125 | 0.001563 | 0.000781 | < 0.001 | so 4 more iterations | | [M1A1] |
| | | | | | | | | | [TOTAL 8] |

| | | | | | | | | |
|----------|---|----------|-----------------|-----------------|-----|--|-----------|--------|
| 2 | h | M | T | S | | | | |
| | 1 | 2.579768 | 2.447490 | 2.535675 | T | | [M1A1] | |
| | 0.5 | 2.547350 | 2.513629 | 2.536110 | S | | [M1A1A1] | |
| | 2.536 secure by comparison of S values. | | | | | | | [E1A1] |
| | | | | | | | [TOTAL 7] | |

| | | | | |
|-------------|---------------------|----------------------|--|--------|
| 3(i) | $f'(x) = 3x^2 - 2x$ | so $f'(0.5) = -0.25$ | | [B1B1] |
| | $f(0.5) = 0.875$ | hence given result | | [B1] |

| | | |
|-------------|------------------------------------|-----------|
| (ii) | Require $-0.0005 < 0.25h < 0.0005$ | [M1A1] |
| | Hence $-0.002 < h < 0.002$ | [A1] |
| | And so $0.498 < x < 0.502$ | [B1] |
| | | [TOTAL 7] |

| | | |
|-------------|------------------------------------|--------|
| 4(i) | Convincing algebra to given result | [M1A1] |
|-------------|------------------------------------|--------|

| | | |
|-------------|--|-----------|
| (ii) | Eg $k = 1000$ correct evaluation to 2 | [B1] |
| | $k = 1000000$ incorrect evaluation to zero (NB some will need larger k) | [B1] |
| | Mathematically equivalent expressions do not always evaluate equally | [E1] |
| | (because calculators do not store (large) numbers exactly) | |
| | Subtraction of nearly equal quantities often causes problems | [E1] |
| | | [TOTAL 6] |

| | | | | | | | |
|------|-----|--------|---------------------------|-----------------|-----------------|-----------|--------|
| 5(i) | x | $f(x)$ | $\Delta f(x)$ | $\Delta^2 f(x)$ | $\Delta^3 f(x)$ | | |
| | 0 | 1.883 | | | | | |
| | 1 | 2.342 | 0.459 | | | 1st diff: | [M1A1] |
| | 2 | 2.874 | 0.532 | 0.073 | | 2nd, 3rd | [F1] |
| | 3 | 3.491 | 0.617 | 0.085 | 0.012 | | |
| | 4 | 4.206 | 0.715 | 0.098 | 0.013 | | |
| | | | 3rd diffs almost constant | | | | [E1] |

| | | |
|------|---|-----------|
| (ii) | $f(1.5) = 1.883 + 0.459 \times 1.5 + 0.073 \times 1.5 \times 0.5 / 2! + 0.012 \times 1.5 \times 0.5 \times (-0.5) / 3!$ | [M1A1A1] |
| | $f(1.5) = 2.598125$ or 2.598 to 3 dp | [A1] |
| | | [TOTAL 8] |

| | | |
|-------|---|--------------|
| 6 (i) | Sketch of smooth curve and its tangent. | [G1] |
| | Forward and central difference chords. | [G1G1] |
| | Clear statement or implication that the central difference chord has gradient closer to that of the tangent | [E1] |
| | | [subtotal 4] |

| | | | | | |
|------|-----|-----------------|-----------------------|------------|--------------|
| (ii) | h | $\tan 60^\circ$ | $\tan (60 + h)^\circ$ | derivative | |
| | 2 | 1.732051 | 1.880726 | 0.074338 | [M1A1] |
| | 1 | 1.732051 | 1.804048 | 0.071997 | [A1] |
| | 0.5 | 1.732051 | 1.767494 | 0.070886 | [A1] |
| | | | | | [subtotal 4] |

| | | | | | |
|-------|-----|-----------------------|-----------------------|------------|--------------|
| (iii) | h | $\tan (60 + h)^\circ$ | $\tan (60 - h)^\circ$ | derivative | |
| | 2 | 1.880726 | 1.600335 | 0.070098 | [M1A1] |
| | 1 | 1.804048 | 1.664279 | 0.069884 | [A1] |
| | 0.5 | 1.767494 | 1.697663 | 0.069831 | [A1] |
| | | | | | [subtotal 4] |

| | | | | | |
|------|---------------------|------------|----------|--|--------------|
| (iv) | forward difference: | derivative | diffs | ratio of diffs | |
| | | 0.074338 | | | |
| | | 0.071997 | -0.00234 | | |
| | | 0.070886 | -0.00111 | 0.474407 (about 0.5, may be implied) | [M1A1A1] |
| | central difference: | derivative | diffs | ratio of diffs | |
| | | 0.070098 | | | |
| | | 0.069884 | -0.00021 | | |
| | | 0.069831 | -5.3E-05 | 0.24896 (about 0.25, less than forward difference, hence faster) | [M1A1E1] |
| | | | | | [subtotal 6] |
| | | | | | [TOTAL 18] |

- 7 (i) Sketch showing $y = 3 \sin x$ and $y = x$ with intersection in $(\frac{1}{2}\pi, \pi)$
State or show that there is only one other non-zero root

[G1G1]
[E1]
[subtotal 3]

- (ii)
- | | | | | | | | |
|-------|---|----------|----------|---------|----------|---------|--|
| r | 0 | 1 | 2 | 3 | 4 | 5 | |
| x_r | 2 | 2.727892 | 1.206001 | 2.80259 | 0.997639 | 2.52058 | |
- clearly not converging
Cobweb diagram to illustrate process

[M1A1A1]
[B1]
[G3]
[subtotal 7]

- (iii) Convincing algebra to given result.

[M1]

| | | | | | | | |
|-------|---|----------|----------|----------|----------|----------|--|
| r | 0 | 1 | 2 | 3 | 4 | 5 | |
| x_r | 2 | 2.242631 | 2.277768 | 2.278844 | 2.278862 | 2.278863 | |

Root appears to be 2.27886 to 5 dp

[M1A1A1]
[A1]

| | | |
|----------|-------------------------|---------------------------------|
| x | $\sin x + \frac{2}{3}x$ | |
| 2.278855 | < 2.2788625 | |
| 2.278865 | > 2.2788627 | hence result is correct to 5 dp |

[M1A1E1]
[subtotal 8]

[TOTAL 18]

Grade Thresholds

Advanced GCE Mathematics 3895 7895

January 2010 Examination Series

Unit Threshold Marks

| Unit | | Maximum Mark | A | B | C | D | E | U |
|-----------|-----|--------------|----|----|----|----|----|---|
| All units | UMS | 100 | 80 | 70 | 60 | 50 | 40 | 0 |
| 4751 | Raw | 72 | 52 | 46 | 40 | 34 | 28 | 0 |
| 4752 | Raw | 72 | 59 | 52 | 45 | 38 | 32 | 0 |
| 4753/01 | Raw | 72 | 57 | 50 | 43 | 36 | 29 | 0 |
| 4753/02 | Raw | 18 | 15 | 13 | 11 | 9 | 8 | 0 |
| 4754 | Raw | 90 | 74 | 65 | 56 | 48 | 40 | 0 |
| 4755 | Raw | 72 | 55 | 47 | 39 | 31 | 24 | 0 |
| 4756 | Raw | 72 | 54 | 46 | 39 | 32 | 25 | 0 |
| 4758 | Raw | 72 | 61 | 53 | 45 | 37 | 29 | 0 |
| 4758/02 | Raw | 18 | 15 | 13 | 11 | 9 | 8 | 0 |
| 4761 | Raw | 72 | 58 | 49 | 41 | 33 | 25 | 0 |
| 4762 | Raw | 72 | 62 | 54 | 46 | 38 | 31 | 0 |
| 4763 | Raw | 72 | 64 | 56 | 48 | 41 | 34 | 0 |
| 4766/G241 | Raw | 72 | 58 | 50 | 42 | 35 | 28 | 0 |
| 4767 | Raw | 72 | 62 | 54 | 46 | 39 | 32 | 0 |
| 4768 | Raw | 72 | 55 | 48 | 41 | 34 | 27 | 0 |
| 4771 | Raw | 72 | 60 | 53 | 46 | 39 | 33 | 0 |
| 4776/01 | Raw | 72 | 60 | 53 | 46 | 40 | 33 | 0 |
| 4776/02 | Raw | 18 | 14 | 12 | 10 | 8 | 7 | 0 |

Specification Aggregation Results

Overall threshold marks in UMS (ie after conversion of raw marks to uniform marks)

| | Maximum Mark | A | B | C | D | E | U |
|------------------|---------------------|----------|----------|----------|----------|----------|----------|
| 7895-7898 | 600 | 480 | 420 | 360 | 300 | 240 | 0 |
| 3895-3898 | 300 | 240 | 210 | 180 | 150 | 120 | 0 |

The cumulative percentage of candidates awarded each grade was as follows:

| | A | B | C | D | E | U | Total Number of Candidates |
|-------------|----------|----------|----------|----------|----------|----------|-----------------------------------|
| 7895 | 27.9 | 61.3 | 84.3 | 95.7 | 98.7 | 100 | 395 |
| 7896 | 54.3 | 62.9 | 88.6 | 100 | 100 | 100 | 35 |
| 7897 | | | | | | | 0 |
| 7898 | | | | | | | 0 |
| 3895 | 27.1 | 54.1 | 74.2 | 88.2 | 97.3 | 100 | 947 |
| 3896 | 41.3 | 67.5 | 86.3 | 95 | 100 | 100 | 80 |
| 3897 | 100 | 100 | 100 | 100 | 100 | 100 | 1 |
| 3898 | 50 | 50 | 100 | 100 | 100 | 100 | 2 |

For a description of how UMS marks are calculated see:
http://www.ocr.org.uk/learners/ums_results.html

Statistics are correct at the time of publication.

OCR (Oxford Cambridge and RSA Examinations)
1 Hills Road
Cambridge
CB1 2EU

OCR Customer Contact Centre

14 – 19 Qualifications (General)

Telephone: 01223 553998

Facsimile: 01223 552627

Email: general.qualifications@ocr.org.uk

www.ocr.org.uk

For staff training purposes and as part of our quality assurance programme your call may be recorded or monitored

Oxford Cambridge and RSA Examinations
is a Company Limited by Guarantee
Registered in England
Registered Office; 1 Hills Road, Cambridge, CB1 2EU
Registered Company Number: 3484466
OCR is an exempt Charity

OCR (Oxford Cambridge and RSA Examinations)
Head office
Telephone: 01223 552552
Facsimile: 01223 552553

© OCR 2010

